

Instrukcja instalacji Smart-UPS™ C 1000/1500 VA prąd zmienny 120/230 V RM-2U

Wyposażenie

Wszystkie modele



(2)

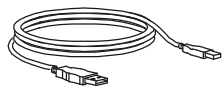

(1)



(2)



(4)



(2)

Modele 1000/1500 VA
prąd zmienny 230 V

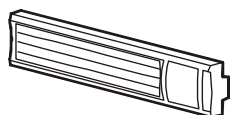

(1)

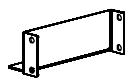

(2)



(2)



(2)



(4)

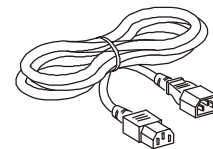

(2)

Instalacja



Baterie są ciężkie. Baterie należy wyjąć przed instalacją UPS w szelaku.

Modele 1000 VA prąd zmienny 120/230 V

1

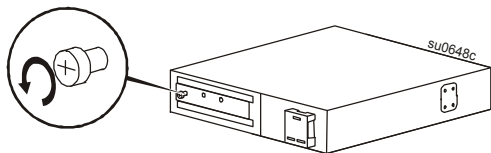

2

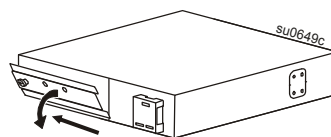

3

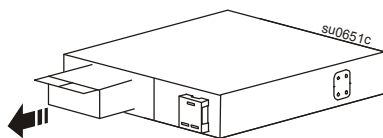

4

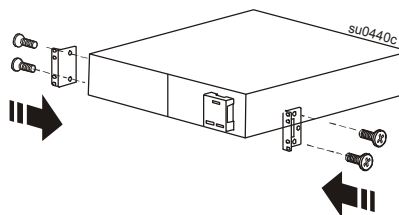

5 Instalacja w szelaku 2 słupkowym

6

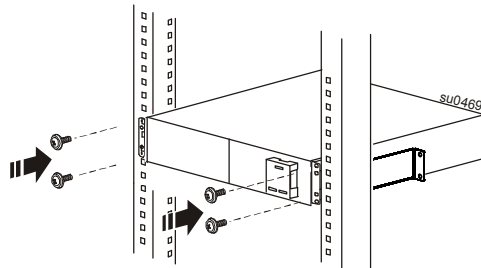
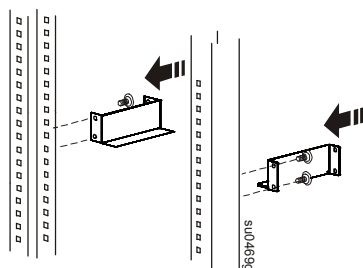

7 Instalacja w szelazhu 4 slupkowym

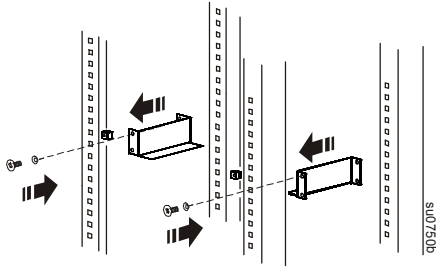

8

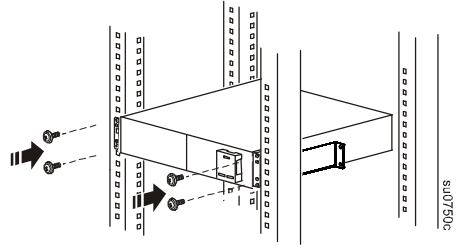

9

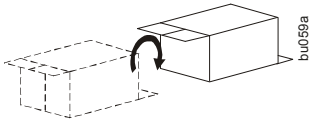

10

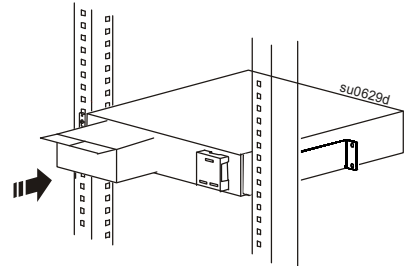

11

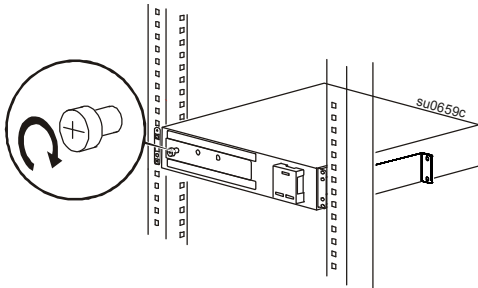

12

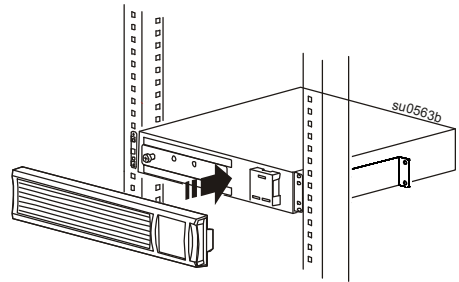

Modele 1500 VA prąd zmienny 120/230 V

1

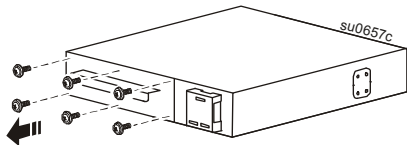

2

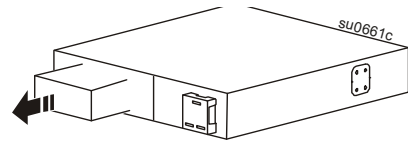

3

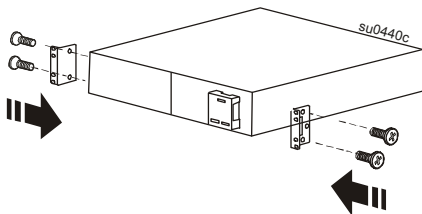

4 Instalacja w szelazhu 2 slupkowym

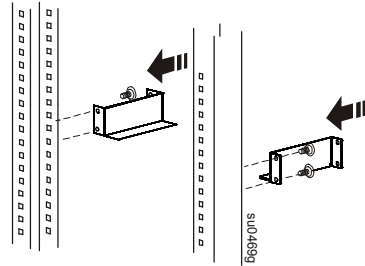

5

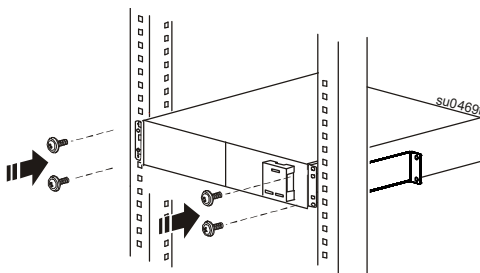

6 Instalacja w szelazhu 4 slupkowym

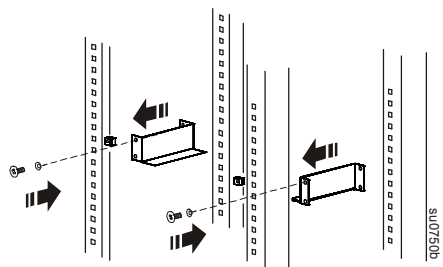

7

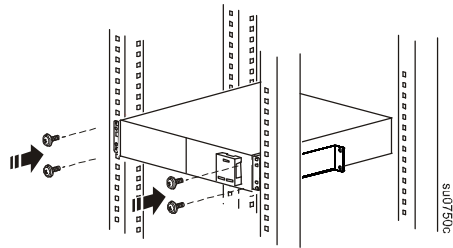

8

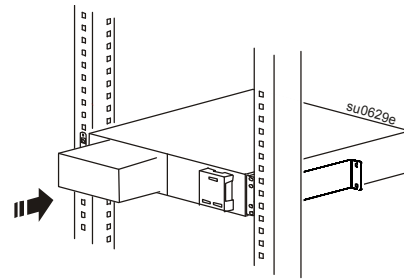

9

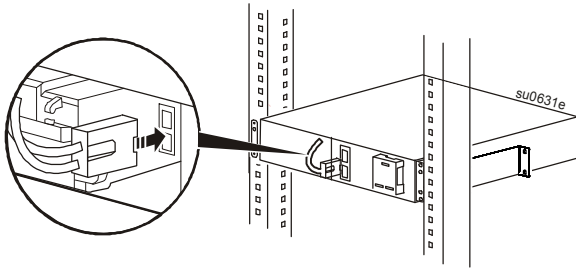

10

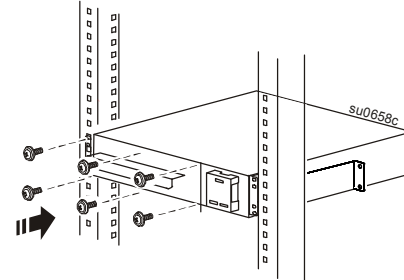

11

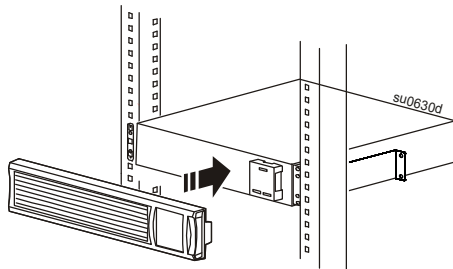

Ogólne informacje o produkcie

Elementy panelu tylnego

Model 1000 VA prąd zmienny 120 V

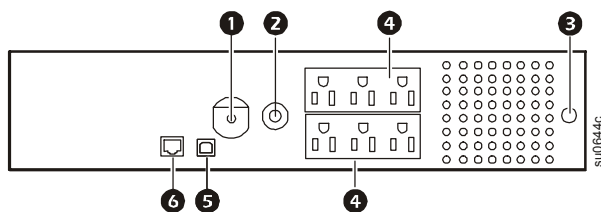

Model 1000 VA prąd zmienny 230 V

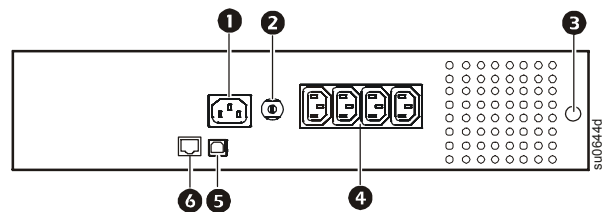

Model 1500 VA prąd zmienny 120 V

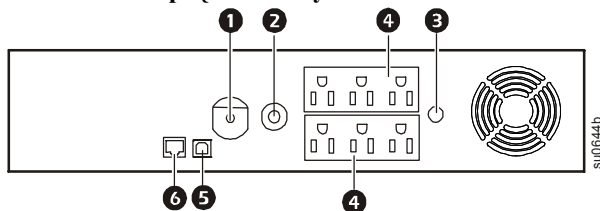

Model 1500 VA prąd zmienny 230 V

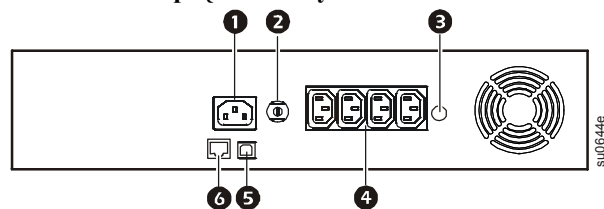

- 1 Wejście UPS
- 2 Wyłącznik automatyczny/zabezpieczenie przeciążeniowe
- 3 Śruba połączenia uziemienia obudowy (GND)

- 4 Wyjścia
- 5 Port USB
- 6 Szeregowy port danych

Połączenia elektryczne

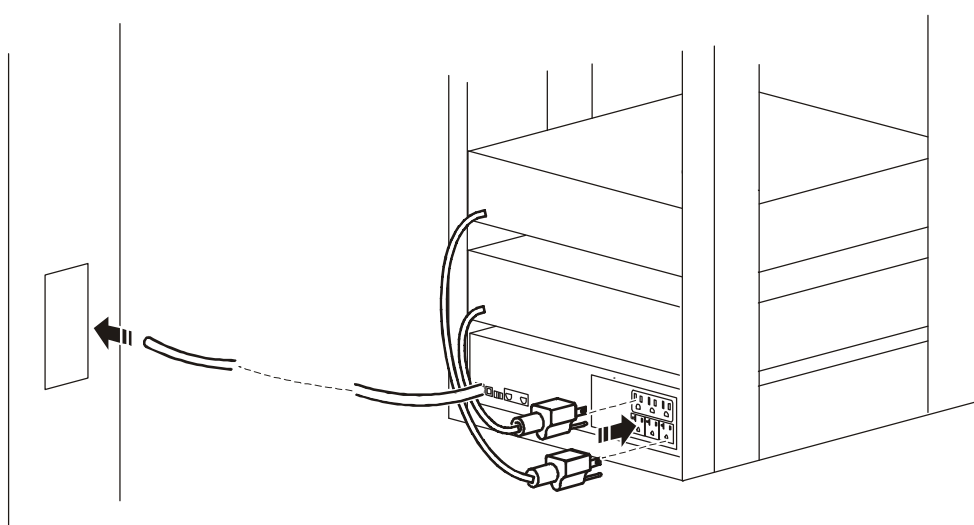

Wyświetlacz na panelu przednim

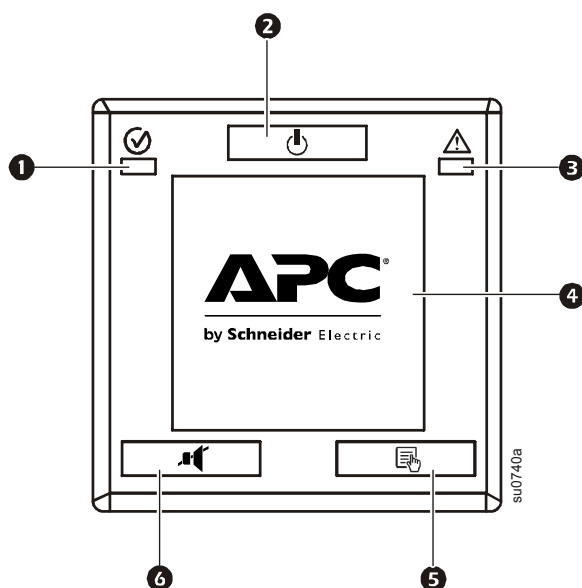

- ❶ Dioda LED Zasilanie sieciowe/
Zasilanie bateryjne
- ❷ Przycisk Power On/Off
- ❸ Dioda LED awarii okablowania
(Wyłącznie modele na prąd
zmienny 120 V)/Awaria systemu
- ❹ Wyświetlacz
- ❺ Przycisk Wyświetlacz
- ❻ Przycisk Wyciszenie