

INSTALLATION

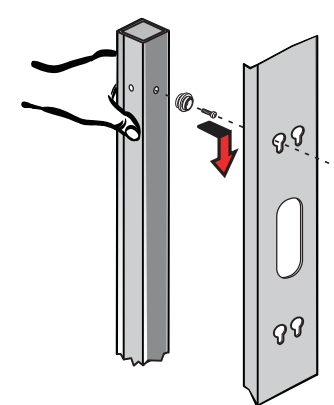

www.eaton.com/ePDU



- or -

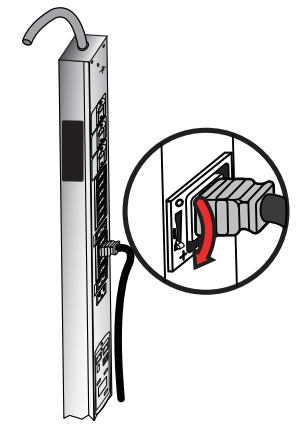
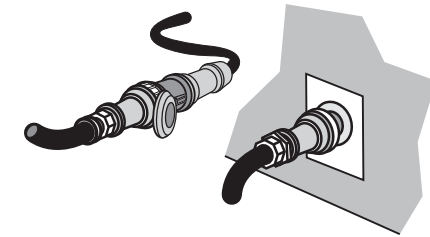
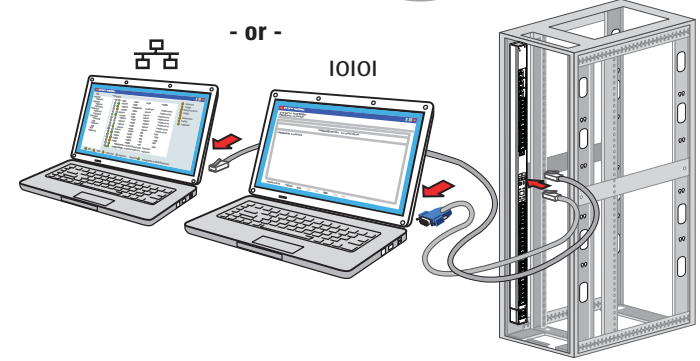
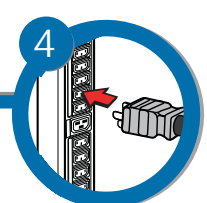
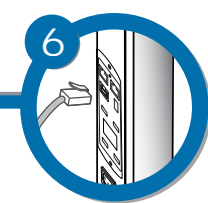
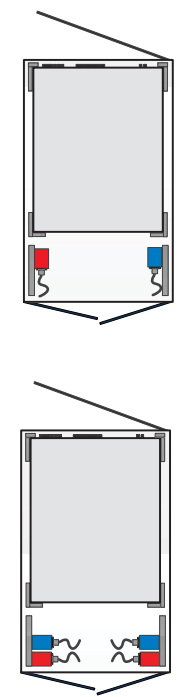
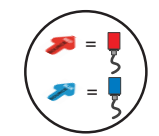
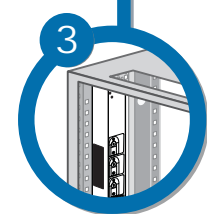
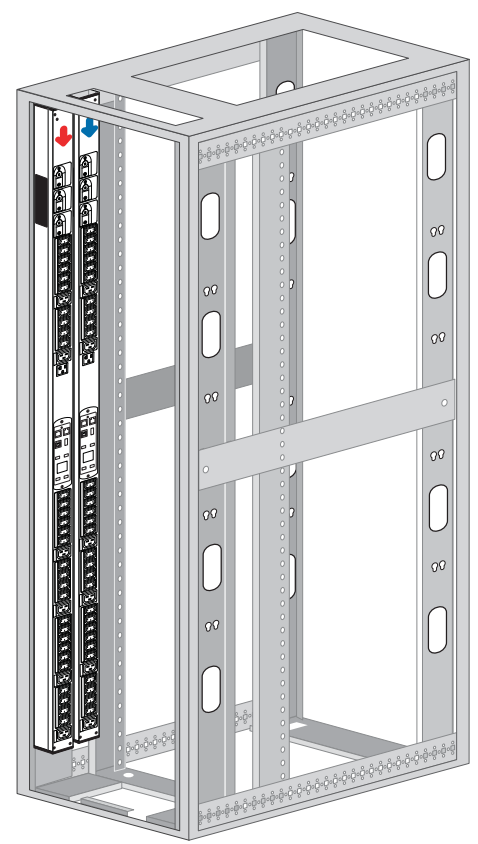
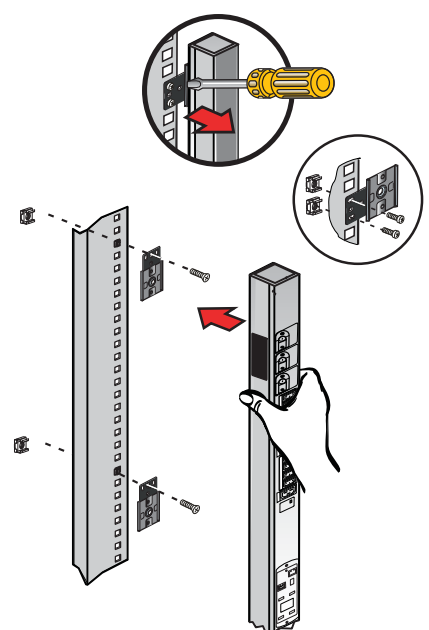

- or -



Unplug the ePDU during installation. Read and understand the safety manual before installation.



Read and understand the operator's manual before using this equipment.

NETWORK CONNECTIVITY

COMMUNICATION MANAGEMENT

Some Eaton ePDU G3 power distribution products have an internal ePDU Network Management and Control (eNMC) module that manages the ePDU communication interfaces. Basic network communication configuration must be performed before the Web or Command Line Interface (CLI) user interfaces can be accessed and used. This sheet describes how to set eNMC parameters and enable the module.

Groups of Eaton ePDU G3 models can be configured or updated with new firmware at the same time using Eaton Intelligent Power Manager (IPM). The IPM software is available separately at no cost for up to 10 devices.

COMMUNICATION STATUS LEDS

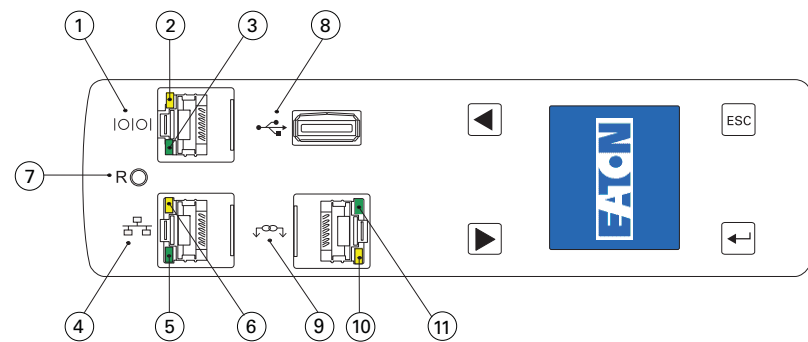

The ePDU front panel includes communication and monitoring ports, LED status indicators, and operation buttons. The ports and the associated LED indicators are described in the following table.

Diagram Reference	Description
1	Serial or Environmental Monitoring Probe (EMP) Port
2	Yellow Serial/EMP Port LED: RS-232 Operation and Activity Status OFF: No EMP connected FLASHING: EMP connected
3	Green Serial/EMP Port LED: ePDU Communication Status OFF: ePDU start-up in progress FLASHING: eNMC module operational
4	Ethernet 10/100 Base-T Port
5	Green Ethernet Port LED: Operation Transfer Rate Status OFF: Port operating at 10 Mbits/s ON: Port operating at 100 Mbits/s
6	Yellow Ethernet Port LED: Connection and Transmission Activity Status OFF: ePDU not connected to the network ON: ePDU connected to the network, but no activity FLASHING: Port is sending or receiving (transmission active)
7	Reset Button Note: To restart the eNMC, insert a probe and press the button for 3 seconds (or until the LCD goes blank). This does not reset power to the outlets.
8	USB Port: Used for Firmware Upgrade Note: Refer to the Eaton ePDU G3 Operation Manual for more information.
9	Daisy Chain Port
10	Yellow Daisy Chain Port LED: Transmission Activity Status FLASHING: ePDU is transmitting data
11	Green Daisy Chain Port LED: Role Assignment in Communication Protocol ON: Device FLASHING: Host

NETWORK COMMUNICATION CONFIGURATION

The network connection automatically receives an IP address through the Dynamic Host Configuration Protocol (DHCP) if available on the network. If a DHCP is enabled but a DHCP server is not available, the eNMC will fall back to the last-used IP address setting. Alternately, it is possible to set a static IP address by using either the LCD menu or a serial connection command (CLI).

You can also connect up to four ePDUs together using the Daisy Chain port and an RJ-45 splitter (provided). This enables multiple ePDUs to communicate over one Ethernet port. Refer to the Eaton ePDU G3 Operation Manual for detailed instructions. View the operation manual online at: <http://www.eaton.com/ePDU>

The default settings are: DHCP: **Enabled** IP Address: **192.168.123.123** Subnet Mask: **255.255.255.0** Gateway: **192.168.123.1** Username: **admin** Password: **admin**

SETUP USING THE LCD – DHCP

- The ePDU defaults to DHCP enabled when delivered.
- Connect to a network that has a DHCP server and wait 20 seconds.
- Obtain the IP address from the LCD home screen.



SETUP USING THE LCD – STATIC IP ADDRESS

1
Disable DHCP

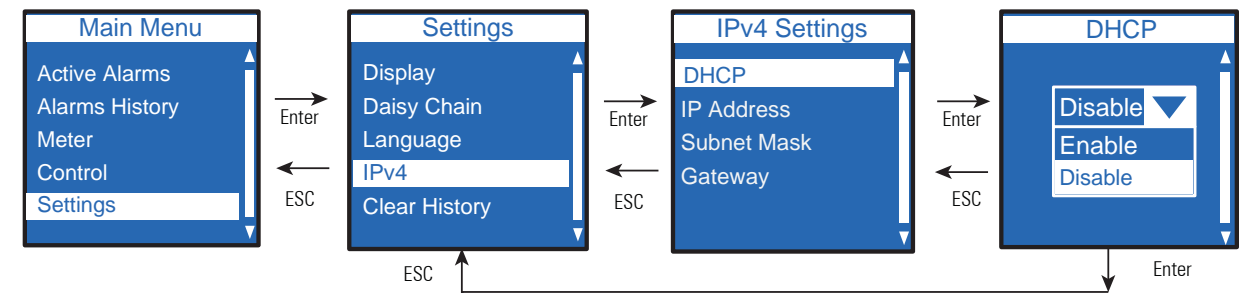

2
Set the Static IP Address

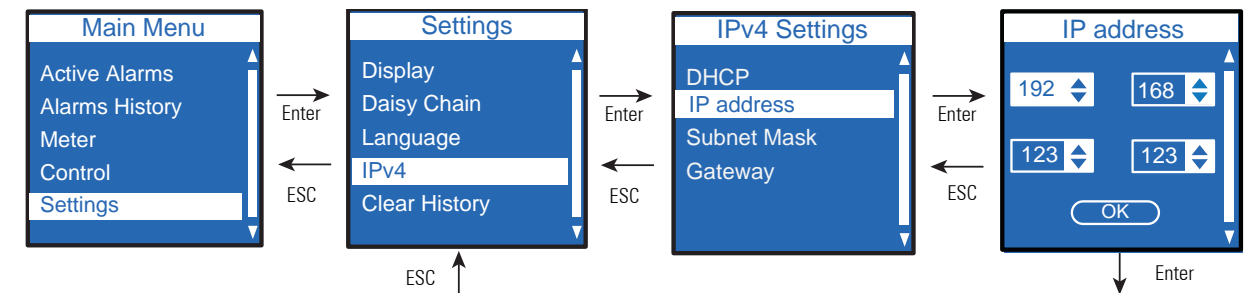

3
Reset and Apply

Wait 10 seconds. Use the reset button to restart the eNMC and apply the new settings.

SETUP USING A SERIAL CONNECTION – STATIC IP ADDRESS

Use the RJ45-to-DB9 serial cable that is provided. If your computer does not have a DB9 (RS-232) connector, a USB-to-RS-232 adapter can be purchased separately. Access the CLI using a terminal emulation program such as HyperTerminal®, PuTTY, or TeraTerm. To set up the serial port using your selected terminal emulation program, use the following settings:

Bits per second: **9600** Data bits: **8** Parity: **None** Stop bits: **1** Flow Control: **None**

After establishing a serial connection, perform the following steps:

- In the terminal emulator session window, enter the default user name (**admin**) at the login prompt. For example:
Enter Login: admin
Enter Password:
- Type **admin** (default) at the password prompt. Press **Enter**.
- The CLI uses a "get" command to return the value of a setting and a "set" command to change the value of a setting. For example:
PDU#0>set System.Network.DHCP 0
PDU#0>get System.Network.DHCP
0
- Type `set System.Network.DHCP 0` and press **Enter** to modify the value (0 = disabled and 1 = enabled). For example:
PDU#0>set System.Network.DHCP 0
- Set the IP address to a value provided by your system administrator.
PDU#0>set System.Network.IPAddress xxx.xxx.xxx.xxx
xxx.xxx.xxx.xxx
- If necessary, set the network Subnet Mask to the value required by your system administrator.
PDU#0>set System.Network.IPMask 255.255.yyy.yyy
255.255.yyy.yyy
- Set the network Gateway to the value required by your system administrator.
PDU#0>set System.Network.IPGateway zzz.zzz.zzz.zzz
zzz.zzz.zzz.zzz
- Wait 10 seconds. Use the reset button to restart the eNMC and apply the new settings.

Note: For alternate instructions to access the CLI using Telnet, refer to the *Eaton ePDU G3 Operation Manual*. View the operation manual online at: <http://www.eaton.com/ePDU>.