

Eaton® Enclosure Power Distribution Unit (ePDU®) G3

Operations Manual



Powering Business Worldwide

Eaton and ePDU are registered trademarks of Eaton Corporation or its subsidiaries and affiliates. Google Chrome is a trademark of Google, Inc. HyperTerminal is a registered trademark of Hilgraeve. Linux is a registered trademark of Linus Torvalds in the United States, other countries, or both. Microsoft, Internet Explorer, Vista, and Windows are registered trademarks of Microsoft Corporation in the United States and other countries. Mozilla and Firefox are registered trademarks of the Mozilla Foundation. National Electrical Code and NEC are registered trademarks of National Fire Protection Association, Inc. Phillips is a registered trademark of Phillips Screw Company. All other trademarks are property of their respective companies.

©Copyright 2011–2014 Eaton Corporation, Raleigh NC, USA. All rights reserved. No part of this document may be reproduced in any way without the express written approval of Eaton Corporation.

Class A EMC Statements

FCC Information

This equipment has been tested and found to comply with the limits for a Class A digital device, pursuant to part 15 of the FCC Rules. These limits are designed to provide reasonable protection against harmful interference when the equipment is operated in a commercial environment. This equipment generates, uses and can radiate radio frequency energy and, if not installed and used in accordance with the instruction manual, may cause harmful interference to radio communications. Operation of this equipment in a residential area is likely to cause harmful interference in which case the user will be required to correct the interference at his own expense.

ICES-003

This Class A Interference Causing Equipment meets all requirements of the Canadian Interference Causing Equipment Regulations ICES-003.

Cet appareil numérique de la classe A respecte toutes les exigences du Règlement sur le matériel brouilleur du Canada.

Eaton is not responsible for damage to this product resulting from accident, disaster, misuse, abuse, non-Eaton modification of the product, or other events outside the reasonable control of Eaton or not arising under normal operating conditions.



Special Symbols

The following are examples of symbols used on the ePDU or accessories to alert you to important information:



RISK OF ELECTRIC SHOCK - Observe the warning associated with the risk of electric shock symbol.



CAUTION: REFER TO OPERATOR'S MANUAL - Refer to your operator's manual for additional information, such as important operating and maintenance instructions.



This symbol indicates that you should not discard waste electrical or electronic equipment (WEEE) in the trash. For proper disposal, contact your local recycling/reuse or hazardous waste center.

Table of Contents

1	INTRODUCTION	1
	Description	1
	Product Specifications	2
	Eaton ePDU Models	2
	LCD Interface	4
	Circuit Breakers	5
	Power Outlets	5
	Input Power Cord	6
	Accessories	6
	Environmental Monitoring Probe	6
	Features	7
	Ease of Use	7
	Communication	7
	Power Control Management	7
	Monitoring	7
	Configurability and Security	8
	Acknowledgements	8
2	SAFETY WARNINGS	9
3	INSTALLATION	11
	Installation Precautions	11
	Inspecting the Equipment	12
	Package Contents	12
	Optional Accessories	13
	Installation Overview	14
	ePDU	14
	Configurations	14
	Power Feed Labels	15
	Chassis Hole Pattern (European models only)	15
	Mounting Buttons	16
	IEC Outlet Grip Plug Retention Mechanism	17
	Installing Vertical ePDUs in a Rack Cabinet	18
	Using Factory-installed Mounting Buttons	18
	Using Mounting Buttons Installed on Clip Feet	19
	Using Clip Feet and Cage Nuts on a Square-hole Rack	20
	Installing the Horizontal Models in a Rack Cabinet	22
	Grounding the ePDU	23
	Network and Environmental Ports	24
	Connecting to a Computer Serial Port	24
	Connecting to a LAN Ethernet Port	25
	Connecting Multiple ePDUs in a Daisy Chain	25
	Connecting Optional Environmental Monitoring Probe Equipment	27
	Connecting the Output Devices	28
	Operating the ePDU	29

4	OPERATION OVERVIEW	30
	Operation Interfaces	30
	Local Operation Interface	30
	Remote Operation Interfaces	31
	Outlets and Circuit Breakers	32
	Ports, Operation Buttons and LED Status Indicators	32
	Operation Concepts	34
	User Login and Access Policy	34
	Common Operations	34
	Starting the ePDU	34
	Shutting Down the ePDU	35
	Restarting the ePDU Network Management and Control (eNMC) module	35
5	NETWORK COMMUNICATION CONFIGURATION	38
	LCD — DHCP	38
	LCD— Static IP address	39
	Serial connection — Static IP address	40
	Verify Web Operation After Configuration	41
6	LCD INTERFACE OPERATION	42
	LCD Display and Control Buttons	42
	Operation Mode	43
	Screensaver Cycling Sequence	43
	Startup Screen	43
	Password Protected Menus	44
	Main Menu Selections	44
	Active Alarms Menu	46
	Alarms History Menu	47
	Meter Menu	47
	ePDU Submenu	47
	Sections Submenu	49
	Outlets Submenu	49
	Environment Submenu	50
	Control Menu	51
	Settings Menu	51
	USB Flash Mode Submenu	52
	Display Submenu	55
	Daisy Chain Submenu	56
	IPv4 Submenu	59
	Language Submenu	59
	Factory Submenu	59
	ePDU Info Menu	60
7	SERIAL INTERFACE OPERATION	61
	Supported Commands	61
	? command	62
	info command	63
	quit command	65
	get command	66

set command	68
pdu command	71
XML Object Tables	72
8 WEB INTERFACE OPERATION	94
Navigating the Web Interface	94
Languages	96
Accessing the Web Interface	97
Menu Selections	97
Power Management	98
Logs & Notifications	98
Settings	99
Network	99
Access Privileges	99
Administrator	99
Local or Remote Administrator	100
ePDU-User	101
Outlet-User	102
Session Management	103
Overview	103
Review/Modify ePDU Data	103
Groups	104
Review/Modify ePDU Groups	104
Outlets	105
Review/Modify ePDU Outlets	105
Environment	106
Configure Environment Sensor Settings	106
Active Alarms	107
Review Active Alarms	107
Logs	108
Clear the Event Log	108
Download the Event Log as a Comma Separated Value File	108
Trap Notification	108
Define the Trap Receivers	108
Syslog	109
Retrieve or Modify Syslog Data	109
Access Accounts	110
Configure the SuperUser	110
Configure the E-mail Notification Settings	110
Configure the LCD Password	111
Configure Local User Access	111
Configure Remote Group Access	112
User-Defined Group Definition	113
Configure an Outlet for a User-Defined Outlet Group	113
System	113
Setting General System Settings	113
Enable/Disable Firmware Upgrade	114
Communications Card Configuration	114

	Perform Firmware Upgrade	115
	ePDU Configuration	115
Date & Time		116
	Manually Configure the Date and Time	116
	Automatically Configure the Date and Time	116
TCP/IP		117
	Configure the Ethernet Link Speed and Duplex Mode	117
	Configure the IPv4 Settings	118
	Configure the IPv6 Settings	118
	Configure the DNS	119
	Configure the SMTP	119
SNMP		120
	Enable/Disable the SNMP Agent	120
	Define SNMPv1 Users	120
	Define SNMPv3 User-based Security Model Users	120
	Access Eaton ePDU MIB Objects (Privileged Access Only)	121
Security		121
	Enable/Disable SSL Encryption	121
	Enable/Disable the Telnet Interface	122
	Enable/Disable the SSH Interface	122
	Enable/Disable FTP	122
	Set Authentication Mode	122
	Set LDAP Search Configuration	123
	Set LDAP Server Global Parameters	124
	Modify LDAP Server Settings	125
	Add RADIUS Server	126
	Edit Parameters for a RADIUS Server	126
9	MAINTENANCE AND ALARMS	127
	Preventive Maintenance	127
	Equipment Disposal	127
	Replacing the ePDU Network Management and Control Module	127
	Reboot the eNMC Module and Reset the ePDU	130
	Firmware Upgrade	130
	Upgrading Firmware with Hypertext Transfer Protocol	130
	Upgrading the Firmware with FTP Protocol	133
	Upgrading the Firmware with the USB Port	134
	Active Alarms	134
	Defining the Alarm or Event Condition	136
	Type Code 0 or 1 (OS or System)	137
	Type 2 or 3 (ePDU or User)	138
10	SERVICE AND SUPPORT	143
	Ordering Optional and Spare Parts	143
11	WARRANTY	144

Chapter 1 Introduction

Description

The Eaton® Enclosure Power Distribution Unit (ePDU®) G3 is an intelligent ePDU that is designed to distribute power within a standard 19-inch rack. A wide range of models let you connect and manage a variety of outlets from a single power connection. Most models have monitoring or switching capabilities, or both.

Figure 1 shows examples of installed Eaton ePDU G3 models.

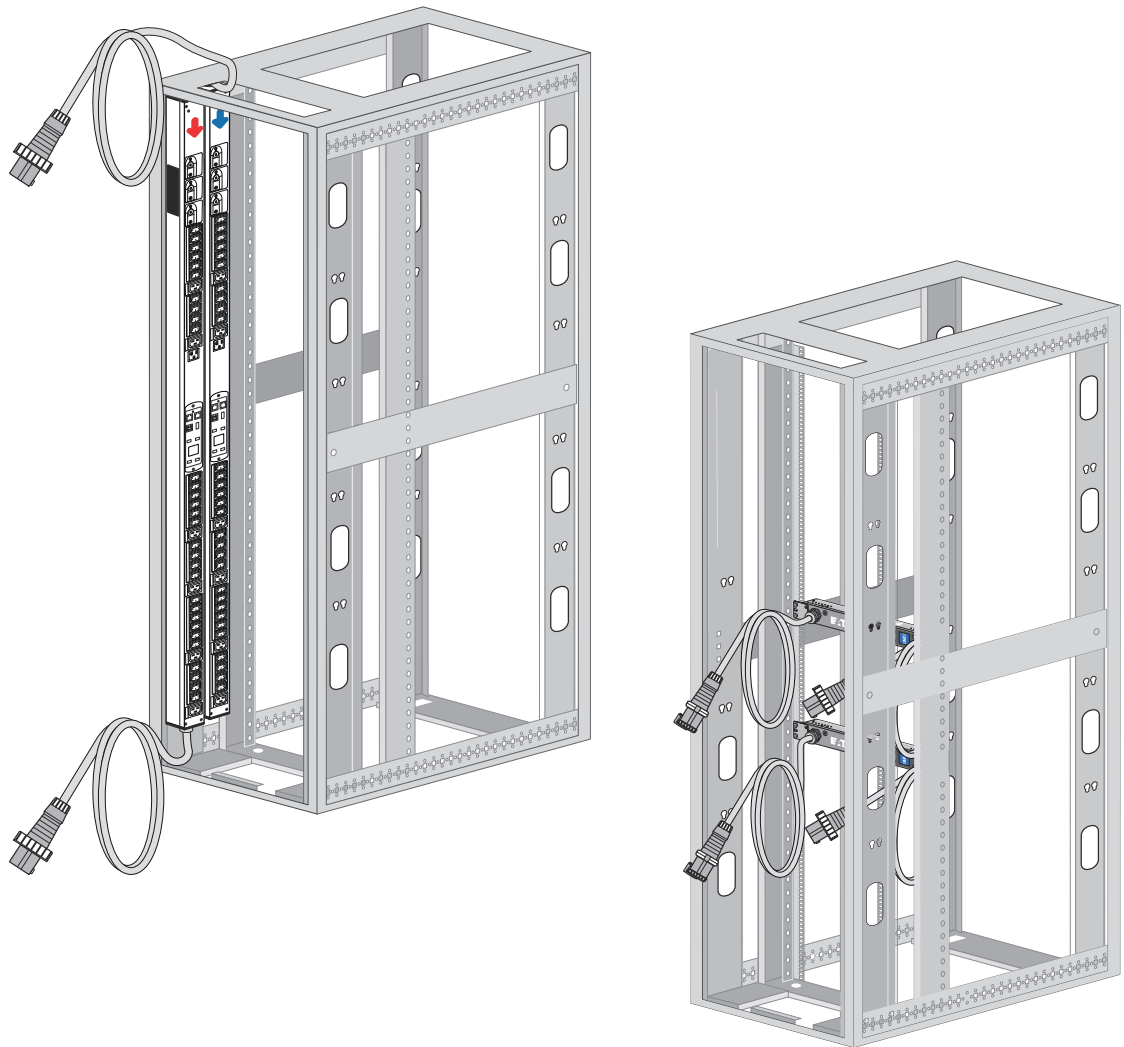

Figure 1. Example ePDU G3 Installations

The ePDU G3 family provides six different ePDU topologies. The monitoring or switching capabilities are characterized as follows:

- Basic (BA) with no monitoring or intelligent controls
- In-Line Metered (IL) with monitoring at the input
- Metered Input (MI) with monitoring at the input and branch
- Metered Outlet (MO) with monitoring at the input, branch, and individual outlet monitoring, but no outlet control
- Switched (SW) with control of outlets but no individual outlet monitoring
- Managed (MA) with monitoring at the input, branch, and individual outlet control and monitoring



NOTE These capabilities are expressed in the model numbers of the ePDUs

Table 1 shows which main features are implemented or not implemented, depending on the topology:

Table 1. Monitoring and Management Features Available for ePDU Topologies

Models	Input Metering	Branch/Outlet Organization	Branch Metering	Outlet Organization	Outlet Metering	Outlet Switching	Sensor Monitoring
Basic (BA)	—	—	—	—	—	—	—
In-Line Metered (IL)	•	—	—	—	—	—	—
Metered Input (MI)	•	•	•	•	—	—	•
Metered Outlet (MO)	•	•	•	•	•	—	•
Switched (SW)	•	•	•	•	—	•	•
Managed (MA)	•	•	•	•	•	•	•

NOTE Environmental monitoring is only available if an Environmental Monitoring Probe (EMP) is attached.

Product Specifications

Find product specifications, diagrams, part number and ordering matrix documents, and marketing collateral at www.eaton.com/ePDU.

Eaton ePDU Models

The Eaton ePDU models support world-wide markets. These model types are defined primarily by the system management and monitoring capabilities, but the capabilities are also defined by the hardware configurations.

The ePDU models support single-phase applications (or three-phase for Americas models) and can manage 6 to 42 outlets. Network-connected models feature an LCD display and LEDs to indicate status on communication connectors. Managed models contain LEDs to indicate outlet status. Most ePDUs have attached power cords and circuit breakers (see Figure 2).



NOTE Select models have detachable input power cords.

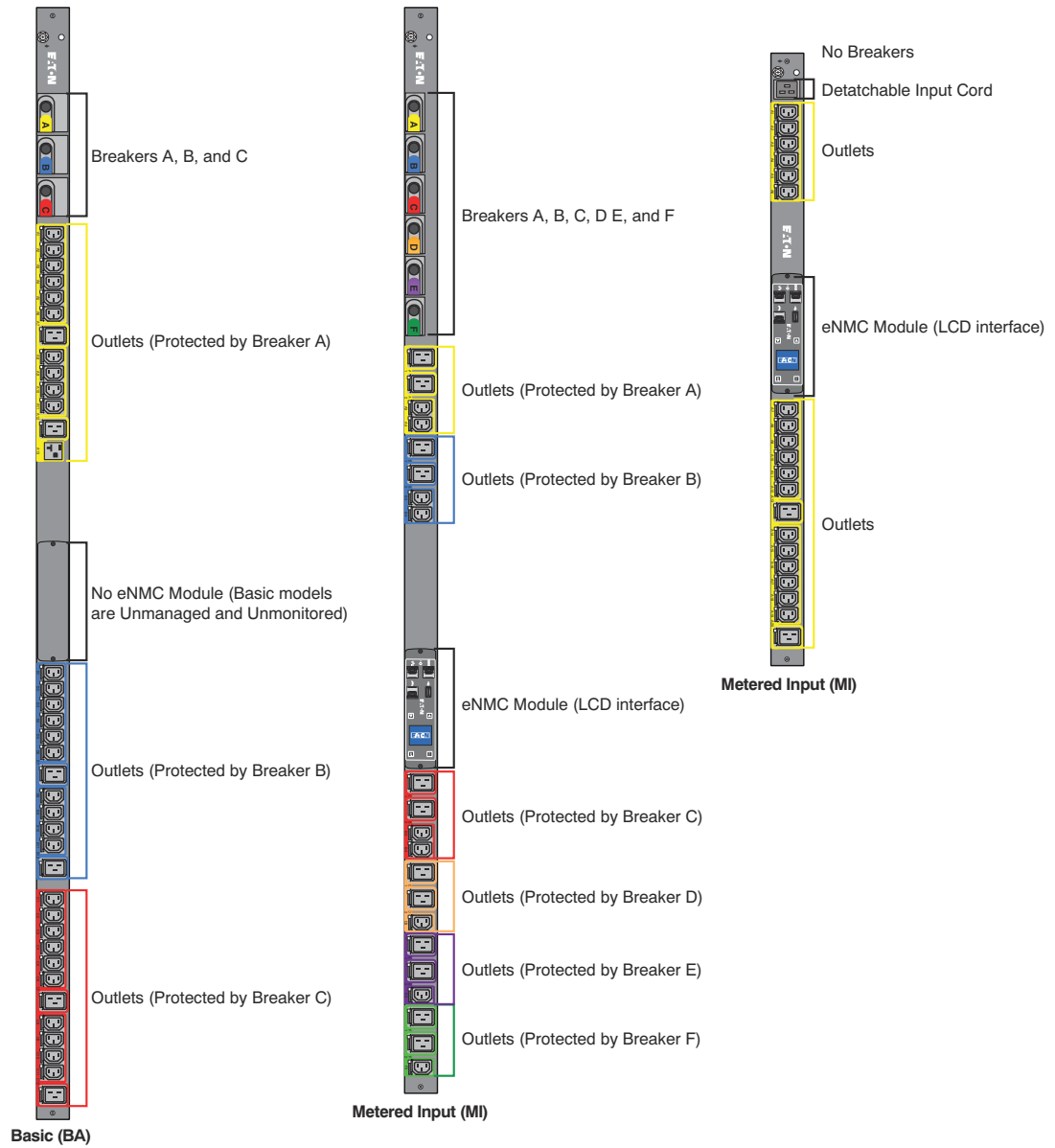

Figure 2. Example ePDU G3 Products



NOTE EMEA models have different markings and laser etching.

LCD Interface

The LCD interface is operated using the LCD display, buttons, and ports of the embedded communications module (ePDU Network Management and Control (eNMC) module). See Figure 3.

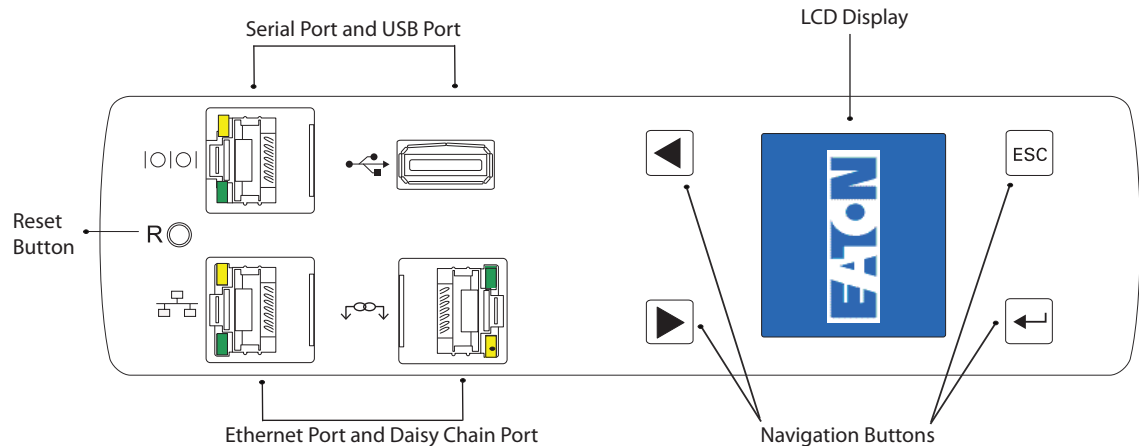

Figure 3. LCD Interface Front Panel

LCD Display

The LCD display provides information about load status, events, measurements, identification, and settings. The LCD interface also provides some basic configuration. For more information, see “Operation Interfaces” on page 28.

Navigation Buttons

Navigate through the display with buttons. For more information, see “Ports, Operation Buttons and LED Status Indicators” on page 30

Reset Button

Restart (reset) the ePDU Network Management and Control (eNMC) module through this button. Insert and retract a probe in the reset button opening to perform a communications module restart.



NOTE Resetting the ePDU does not affect the power to the outlets.

Connectivity and Serial Ports

- **Serial or Environmental Monitoring Probe (EMP) Port.** Connects to the serial (COM) RS-232 connector on a computer with a DB9-to-RJ-45 cable, allowing the computer to act as a configuration console. As an alternative, the connection can be used to connect an optional EMP in order to collect temperature and humidity data.
- **Ethernet Port Connector.** Connects to a LAN, allowing configuration through a 10/100 autosensing network connection.
- **Daisy Chain Port Connector.** Used to daisy-chain two to four ePDUs together to use a single Ethernet connection.
- **USB Port.** Used for firmware upgrade.

Circuit Breakers

Circuit breakers activate if the load current rating of an outlet section exceeds 16A (Europe) / 20A (US). Power to the outlet turns off automatically. To reset the circuit breaker, turn the breaker from Off to On.

NOTE 1 The On/Off positions are indicated on the circuit breakers.



NOTE 2 To manually disconnect power to a device that is connected to the ePDU, disconnect the device power cord from the ePDU outlet.

NOTE 3 To disconnect power on models without a circuit breaker, disconnect the ePDU input power cord.

Figure 4 shows circuit breaker examples.

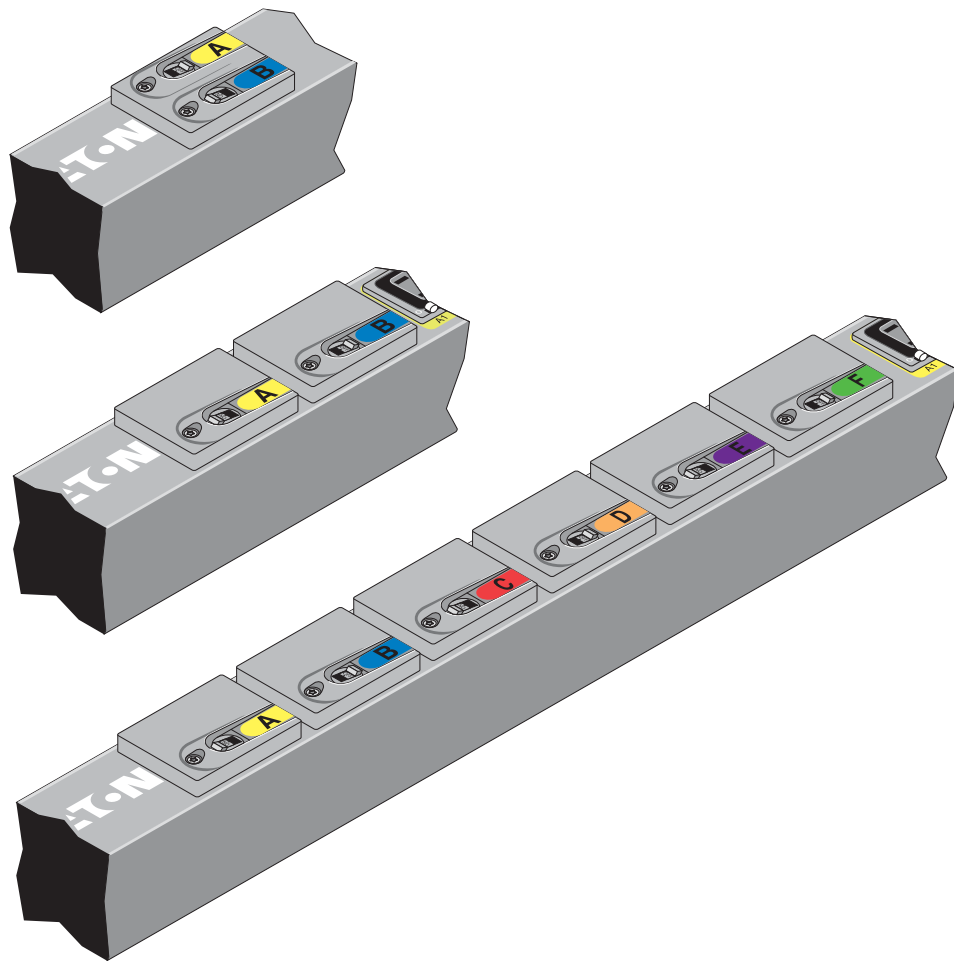

Figure 4. Circuit Breakers

Power Outlets

Each model has a specific configuration of standard NEMA outlets, IEC 60320 and IEC 60309 outlets, European national types (French, Schuko, and UK), or other outlet types (for example, RF-203P-HP 277 VAC). Many configurations are available or the configurations can be customized to match your needs and your locale.

The outlets are grouped in sets called sections. Outlet sections are preset groups of individual outlets that you can identify and monitor through the different interfaces that are available with the ePDU.

The outlets are color-coded and labeled. If the model has circuit breakers, the circuit breakers that are associated with the outlets have corresponding labels (see Figure 5).

You can connect one device to each outlet. For more information, see “Outlets and Circuit Breakers” on page 30.

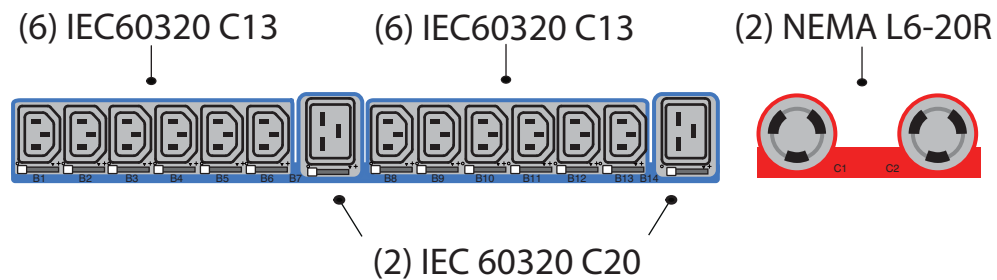

Figure 5. Example Outlet Types

Input Power Cord

Use the input power cords to connect to the power source. Input power cords are permanent for most models. Select models have detachable input power cords.

Accessories

Environmental Monitoring Probe

The Environmental Monitoring Probe (EMP) accessory is optional and must be purchased separately. The optional EMP provides monitoring of external temperature, humidity, and the status of two contact devices, providing greater power management control and flexible monitoring. The EMP has the following features:

- Simplified installation lets you install the EMP safely without turning off power to the ePDU or to the devices that are connected to it.
- The EMP monitors temperature and humidity information of any environment, protecting your critical equipment. The EMP measures temperatures between 0°C and 80°C (32°F and 176°F) with an accuracy of $\pm 1^\circ\text{C}$. The EMP measures relative humidity between 10% and 90% with an accuracy of $\pm 5\%$.
- The EMP can be located away from the ePDU with a Category 5 network cable up to 20m (65.6 ft) long.
- The EMP monitors the status of two user-supplied contact devices.
- Temperature, humidity, and contact closure status can be displayed through a variety of interfaces.
- User-selectable alarm thresholds let you define acceptable temperature or humidity limits.
- You can use e-mail client software to set up e-mail notification through Simple Network Management Protocol (SNMP) when acceptable alarm limits are exceeded or contact status changes.
- Changes in external contact status are logged in the ePDU event history log.
- When temperature and humidity values exceed user-selectable limits, the event is logged in the ePDU event history log.

**NOTE**

For information updates, refer to the Eaton ePDU catalog or go to www.eaton.com/ePDU.

Features

The Eaton ePDUs provide outstanding performance and reliability, including the some or all of these benefits (varies by model):

Ease of Use

- Easy and flexible rack installation
- Easy-to-use interface to display input and output status
- Color-coded outlets and circuit breakers for easy correlation
- A visual alarm (blinking LED) to indicate outlet current overload
- User-friendly firmware updates

Communication

- Comprehensive power management and flexible configuration through a Web browser or a serial connection, a Telnet connection, SNMP, or a console emulator such as HyperTerminal®
- Compatibility with Eaton and third party network management software is facilitated by SNMP protocol or CLI scripts. Eaton Intelligent Power Manager (IPM) uses XML to communicate to the ePDU.

Power Control Management

- Control of outlets for Switched or Managed ePDUs, both collectively and individually
- The ability to power on, power off, and reboot the devices connected to each outlet
- Fully shrouded local branch circuit breakers on products rated over 16A (Europe) / 20A (US) to protect connected equipment against overload and short circuits
- Configuring and monitoring the power schedule of outlets
- Configuring collocated users as a user group with restricted access to user-defined outlet groups

Monitoring

- Monitoring of the following:
 - Root Mean Square (RMS) current
 - Crest factor
 - Power factor
 - Maximum and minimum thresholds for current or voltage
 - RMS voltage
 - Active power
 - Apparent power
 - Energy
- Monitoring of the ePDU locally or remotely through a console or network
- Remote monitoring of connected devices and sensors
- Daily history report through e-mail
- Dual color LCD for higher visibility on local alarms

Configurability and Security

- Configurable alarm thresholds
- Configurable user access control through collocation
- Enterprise security using LDAP or RADIUS

Acknowledgements

The Eaton software development team is grateful to the following projects:

- OpenLDAP (<http://www.openldap.org/>)
- Cyrus SASL developed by Computing Services at Carnegie Mellon University (<http://www.cmu.edu/computing/>)
- uthash hash table (<http://uthash.sourceforge.net>)
- Expat XML Parser
- Symmetric Cipher Algorithm (Pukall Cipher 1) by Alexander PUKALL
- STM32F2xx standard peripherals library STSW-STM32062 by STMicroelectronics
- Radius library (<http://freeradius.org>)

The full license version for each of these projects is available in the web interface main page from the ePDU information panel by clicking the link next to the "Licenses" label.

Chapter 2 Safety Warnings

IMPORTANT SAFETY INSTRUCTIONS — SAVE THESE INSTRUCTIONS

This manual contains important instructions that you should follow during installation and operation of the Eaton Enclosure Power Distribution Unit (ePDU) G3. Please read all instructions before operating the equipment and save this manual for future reference.

DANGER

This ePDU contains **HAZARDOUS VOLTAGES**. All repairs and service should be performed by **AUTHORIZED SERVICE PERSONNEL ONLY**. There are **NO USER SERVICEABLE PARTS** inside the ePDU. **SYSTEMS SHOULD ONLY BE INSTALLED, TESTED, AND CONFIGURED BY A COMPETENT PERSON. IT IS ESSENTIAL THAT THIS EQUIPMENT IS CONNECTED TO AN ELECTRICAL SUPPLY THAT HAS PROTECTIVE GROUND CONDUCTOR.**

CAUTION

- To reduce the risk of fire or electric shock, install this ePDU in a temperature and humidity controlled, indoor environment, free of conductive contaminants. Do not operate near water or excessive humidity (95% maximum).
 - Both the room and rack air temperature must be within the operating range of the selected model.
 - Do not use a two-wire power cord in any product configuration.
 - Test AC outlets at your computer and monitor for proper polarity and grounding. Use only with grounded outlets at both the computer and monitor.
 - The installation power outlet used for the power supply to this equipment must be installed near the equipment and must be easily accessible.
 - When installing this product, it is essential that the distribution circuit supplying the product is protected by a branch circuit protection device with a maximum rating to suit the product maximum rating.
 - TO ISOLATE THIS EQUIPMENT, DISCONNECT ALL OF THE POWER SUPPLY PLUGS.
 - This product has been designed to conform to the latest safety requirements. In addition to compliance with standards for general use, it has been factory configured for use in rack mounting environments, aiding the installer in providing systems compliant with relevant standards.
 - Only use supplied ePDU mounting hardware and accessories. If necessary, contact your customer service representative for replacement parts.
 - This equipment is intended for installation in Restricted Access Locations such as computer rooms, network closets, and equipment racks.
-

 **CAUTION**

This product contains a lithium battery on the internal ePDU Network Management and Control (eNMC) module:

- The battery is not user-replaceable. There is risk of explosion if battery is replaced by an incorrect type.
 - Ensure that used batteries are disposed of according to the instructions. For more information, contact your local recycling/reuse or hazardous waste center for proper disposal information.
-

Chapter 3 Installation

All 0U Eaton Enclosure Power Distribution Unit (ePDU) G3 models are mounted vertically inside rack structures. The In-line Metered (IL) models are mounted horizontally. Use the information in this chapter to prepare, install, and connect the ePDU and optional accessories.

Installation Precautions

Before you install or connect the ePDU in a rack cabinet, observe the following precautions:

- Only a competent service person should install, test, or configure the ePDU and its optional accessories. It is the installer's responsibility to ensure that the selected product is installed to meet national and local safety regulations.
- Read and understand all warnings and cautions listed in "Safety Warnings" on page 9.
- Review the documentation that comes with your rack cabinet for safety and cabling information. Follow all installation and operation safety information provided.



NOTE

Removing the rack cabinet doors and side panels might make installation easier. See the rack cabinet documentation for more information.

- Verify that the room and rack air temperature is within the operating range of the selected model.
- Take all necessary precautions to handle the weight of the devices.
- Connect all power cords to properly wired and grounded electrical outlets.



CAUTION

The installation power outlet used for the power supply to this equipment must be installed near the equipment and must be easily accessible.

- Do not overload the power outlet when you install multiple devices in the rack cabinet.
- To reduce the risk of fire, connect only to a circuit provided with branch circuit overcurrent protection with an A (ampere) rating in accordance with the NEC (National Electrical Code), ANSI/NFPA 70 or your local electrical code.
- Verify that all equipment is unplugged from ePDU outlets before performing any testing.
- For units without circuit breakers, the ePDU output power cannot be turned on and off with a button or switch. These ePDUs are always on when they are plugged in. These ePDUs are always off when they are unplugged.
- For units with circuit breakers, the circuit breaker controls whether there is output power:
 - If the circuit breakers are on, there is output power, the LCD display is on, and the network communications module is operational.
 - If the circuit breakers are off, there is no output power, but the LCD display is on, and the network communications module is operational.
 - To turn off the ePDU, unplug it.

Inspecting the Equipment

If any equipment has been damaged during shipment, keep the shipping cartons and packing materials for the carrier or place of purchase, and file a claim for shipping damage. If you discover damage after acceptance, file a claim for concealed damage.

To file a claim for shipping damage or concealed damage: 1) File with the carrier within 15 days of receipt of the equipment; 2) Send a copy of the damage claim within 15 days to your service representative.

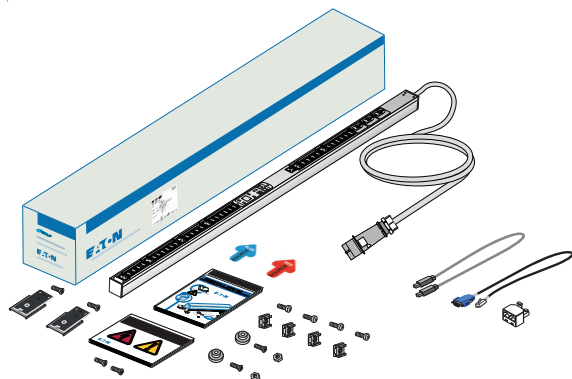

Figure 6. Example Shipping Carton and Contents

Package Contents

Table 2 lists the accessory parts that are included in the shipping carton with the ePDUs.

Table 2. Shipped with the ePDU in the Shipping Carton



Quantity	Description	
1 per language (varies by market)	<i>Eaton ePDU G3 Installation and Connectivity Quick Start (English)</i> (P-164000314) NOTE Supplied in the shipping carton and also available in several languages at www.eaton.com/ePDU .	
1 per language (varies by market)	<i>Eaton ePDU G3 Safety Warnings and Service Reference Manual (English)</i> (P-164000326) NOTE Supplied in the shipping carton and also available in several languages at www.eaton.com/ePDU .	

Table 2. Shipped with the ePDU in the Shipping Carton(Continued)

Quantity	Description
1	<p>Installation Pack for all models:</p> <p>(1) Blue and (1) Red Arrow to indicate power source flow</p> <p>(2) Spare black plastic key hole buttons, (2) M4 screws (thread-forming), and (2) M4 nuts</p> <p>(4) M6 Cage nut, (4) M6 dome screws, and (2) M6 Flat head screws</p> <p>(2) Clip feet and (2) M6 Flat head screws</p> <p>NOTE You may also have (2) M4 spare screws.</p>



1	<p>Network Pack for Network-connected models only:</p> <ul style="list-style-type: none"> • (1) Serial cable used for RS-232 connection between the ePDU and a PC • (1) RJ-45 Cable (60cm - shielded) used for Ethernet or daisy-chain connection between the ePDU and a PC <small>SEE NOTE</small> • (1) Y Splitter installed in the Daisy-chain port and used for daisy-chaining three or four ePDUs together,
---	--

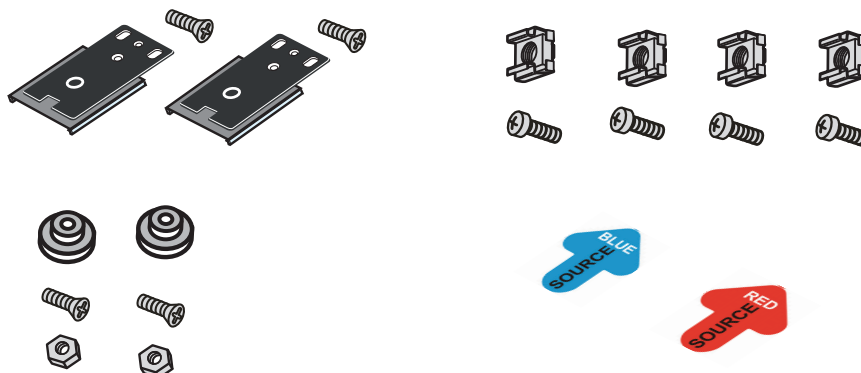
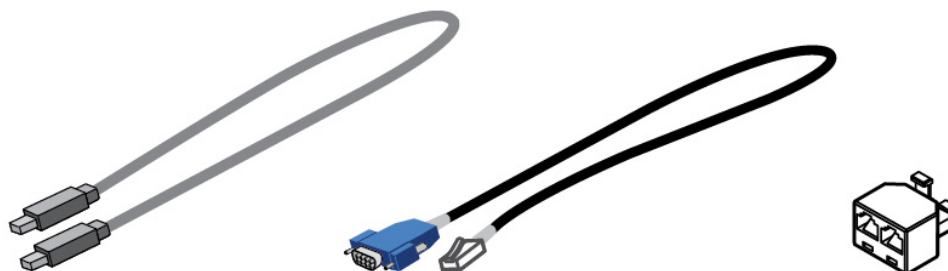

NOTE The short Ethernet cable is intended for setup or daisy chain. Longer standard network cables can be made or purchased separately.

NOTE Some ePDUs have detachable power cords which may or may not be included. Check specifications prior to ordering.

Optional Accessories

Optional Environmental Monitoring Probe (EMP) equipment with sensors can be connected to the ePDU as an accessory. The equipment is customer-supplied and should be installed using the manufacturer’s instruction manual.

! IMPORTANT

Follow all installation and operation safety information provided in the manufacturer’s instruction manual for the EMP equipment. Use only supplied accessories.

Installation Overview



- NOTE 1** Power cords for the devices that you connect to the ePDU are not included.
- NOTE 2** Depending on your choice of installation method, some parts may not be used.
- NOTE 3** Use only the supplied screws for installation. Hand tighten the screws. Do not overtighten to avoid stripping the screws.
- NOTE 4** The mounting button screws are thread forming. When tightening or removing a thread forming screw initially, the fit may be tighter than usual.
- NOTE 5** If a square-hole rack is used, cage nuts must be installed.



IMPORTANT

Use great care in handling the ePDU during installation. Avoid unnecessary contact between the ePDU and the rack.

ePDU

The ePDU G3 is designed to be mounted without the use of tools. Mounting buttons are pre-installed on the rear of the ePDU at the factory. If you wish to use a different mounting option, such as the clip foot or side mounting, tools may be required as follows:

- Phillips cross-head screwdriver
- Flat-blade screwdriver
- 0 mm (11/32") wrench
- M6 screws and M6 cage nuts
- M6 cage nut insertion tool
- T-25 TORX® driver

Configurations

You can install one or two ePDUs vertically on each side of the rack (see Figure 7).

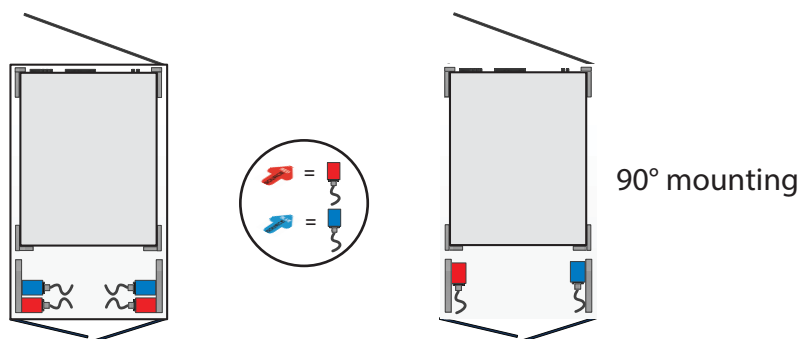

Figure 7. Vertical ePDU Configurations

You can install one or two In-line Metered (IL) models horizontally (see Figure 8).

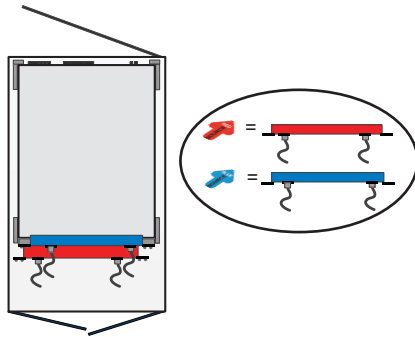

Figure 8. Horizontal Model Configurations

Power Feed Labels

Adhesive power feed labels (red power feed arrow and blue power feed arrow) are supplied to allow identification of the power flow for up to two individual ePDUs. The customer can choose the location of the sticker in an available space on the unit or the rack. Adhere one to the side of an ePDU at your discretion to indicate the power feed direction (see Figure 9).

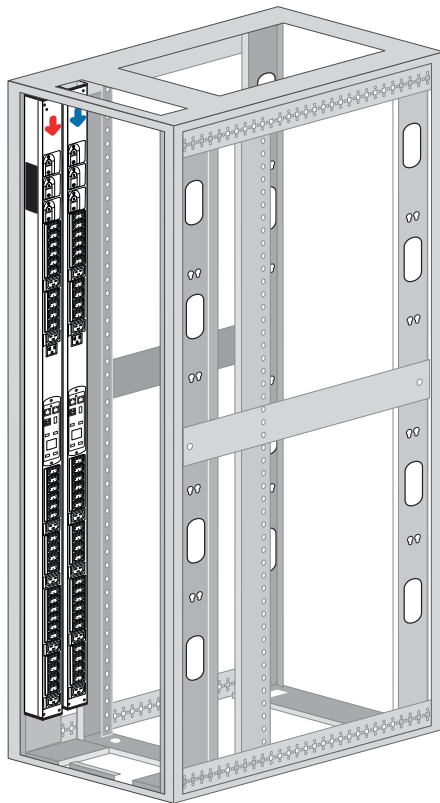

Figure 9. Power Feed Labels

Chassis Hole Pattern (European models only)

The European models have markings and extra holes on the back of the ePDU to accommodate different mounting requirements in European racks.

You can move the ePDU up or down in the rack in 10mm intervals to ensure best fit. This standard system uses 622 mm, 933 mm, 1244 mm, 1384 mm and 1556 mm, depending on the overall length of the ePDU (see Figure 10).

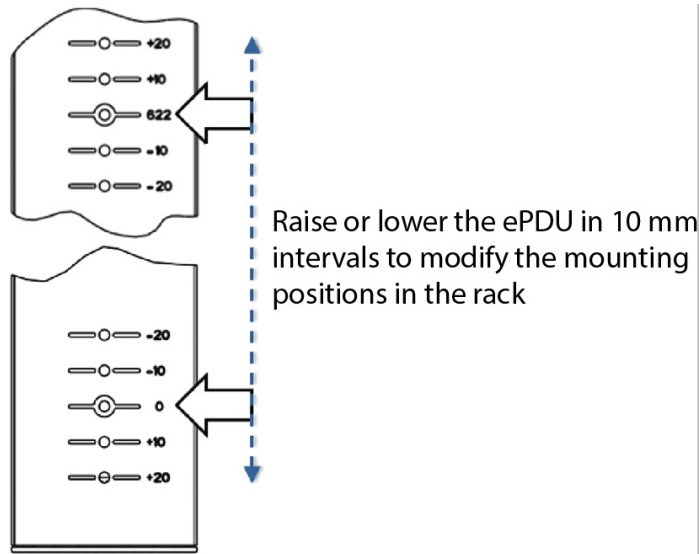

Figure 10. Raise or Lower Mounting Position in the Rack

You can also choose the appropriate distance between the keyhole buttons based on 0 value (see Figure 11).

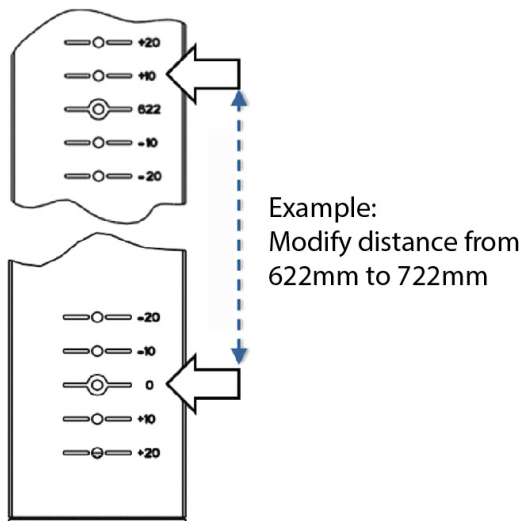

Figure 11. Change Distance Between Button Mounts for Different Racks

Mounting Buttons

The mounting buttons for 0U vertical ePDUs are factory installed. This is a two-sided button that provides either a 2.1 mm or 2.3 mm mounting channel for a custom fit. If you discover that the rack wall is too thick or too thin and the button does not secure the ePDU, unscrew and remove the button from the ePDU. Then, flip it to the reverse side (see Figure 12). To distinguish the sides, one side is marked with a black painted ring. (For European models, you must not see the black ring when installed.)

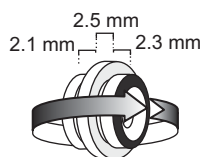

Figure 12. Reversible Factory-installed Mounting Button

Two unattached plastic mounting buttons are included in the standard hardware kit with thread-forming M4 screws and nuts for Americas, or M3 screw and nuts for EMEA (see Figure 13). These buttons provide a 2 mm mounting gap. These are supplied in case the default metal solution is not well suited to the rack. Or, you can use these when you attach mounting buttons to clip feet to install the Eaton ePDUs. Your kit may also contain two additional spare M4 screws.



Figure 13. Extra Plastic Keyhole Buttons

IEC Outlet Grip Plug Retention Mechanism

The Eaton ePDUs have a mechanism integrated with the outlets to retain a plug inside its outlet. This system is a lever-actuated grip that prevents the plug from accidentally being bumped out or vibrating out of the outlet. It is not a locking device so the plug can still be removed in an emergency.

To operate the grip mechanism:

1. Make sure the locking lever is on the “O” position before inserting the plug.
2. Plug in the power cord.
3. Gently rotate the lever to the “+” position. You should hear a “click” sound as the plug retention mechanism engages.
4. To remove the plug, gently rotate the lever to the “O” position. Remove the plug.

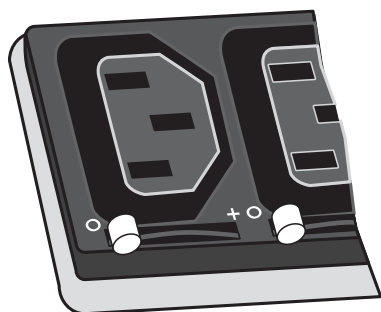

Figure 14. Plug Retention Mechanism



NOTE

Only unplug the power cord when the grip plug retention mechanism is in the “+” position in the event of an emergency.



NOTE If you choose, you can further secure the plug with a cable tie.

Installing Vertical ePDUs in a Rack Cabinet

Regardless of the configuration you choose, there are three mounting methods available for installing the ePDU vertically in a rack cabinet:

- Using factory-installed buttons on the ePDU to mount the ePDU in keyhole openings in the rack frame
- Using buttons on clip feet to mount the ePDU in keyhole openings in the rack frame
- Using clip feet and cage nuts secured to the rack to mount the ePDU onto the clip

Review the installation methods described in this section and choose the method appropriate for your environment.



NOTE If you need to remove the ePDU from clip feet, hold on to the ePDU and use a flat screwdriver to unsnap it from the clip.

Using Factory-installed Mounting Buttons

To install the ePDU with mounting buttons directly attached to the ePDU:

1. Carefully move the ePDU into position against the rail.
2. Insert the top and bottom mounting buttons into the keyhole slots on the rack post that correspond with the position of the top and bottom mounting buttons.
3. Does the factory-installed mounting button fit flush in the rack keyhole?
 - If no, go to Step 4.
 - If yes, go to Step 5.
4. Unscrew and remove the mounting button. Turn it around 180°. Secure the mounting button to the ePDU (see Figure 15).



Figure 15. Reversing the Mounting Button

5. Push down to secure the ePDU in position (see Figure 16).
6. Continue to “Grounding the ePDU” on page 23 if you are installing a ground screw and grounding cable. Otherwise, go to “Network and Environmental Ports” on page 24.



NOTE The ePDU will fit tight and it may require minor force to engage in the slot. This is a friction fit to hold the ePDU in the slot.

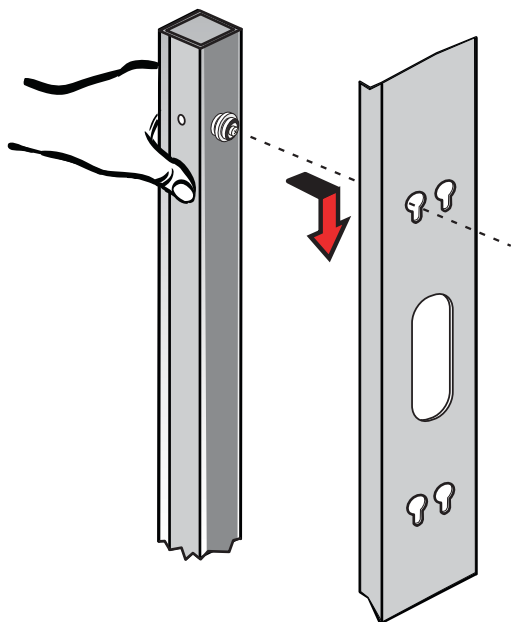

Figure 16. Securing the ePDU

Using Mounting Buttons Installed on Clip Feet

To install the ePDU with mounting buttons installed on the mounting clip feet:

1. Locate the two mounting clip feet, M6 flathead screws, two spare plastic mounting buttons, and mounting hardware (M4 screws and M4 hex nuts). Using a Phillips screwdriver, assemble the mounting buttons and clip feet (see Figure 17).

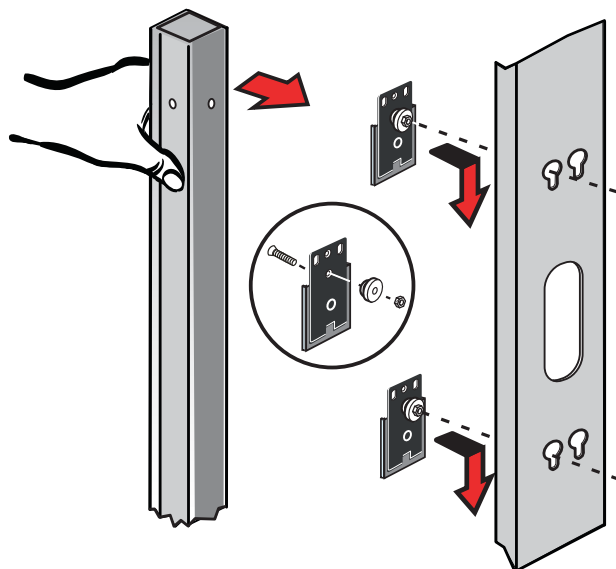
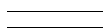

Figure 17. Attaching the Mounting Buttons to the Mounting Clip Feet



2. Mount the two clip assemblies in keyholes spread far enough apart to stabilize the top and bottom of the ePDU when mounted on the rail. See “Chassis Hole Pattern (European models only)” on page 15 for more information.
3. Carefully move the ePDU into position against the rail.
4. Snap the ePDU into the clip feet at the desired vertical position.
5. Align the clip feet and slide the mounting button into the keyhole slots.
6. Push down to make sure the ePDU is secured into position.
7. Continue to “Grounding the ePDU” on page 23 if you are installing a ground screw and grounding cable. Otherwise, go to “Network and Environmental Ports” on page 24.

Using Clip Feet and Cage Nuts on a Square-hole Rack



NOTE You can install the mounting clip feet vertically or horizontally.



NOTE If a square-hole rack is used, cage nuts must be installed. Use a cage nut insertion tool or a flat-blade screwdriver to install the cage nuts.

To install the ePDU with clip feet secured by cage nuts:

1. Locate the cage nuts (supplied).
2. Are you mounting the ePDU on the rail or away from the rail (offset)?
 - If on the rail, go to Step 3.
 - If away from the rail, go to Step 5.
3. **ePDU on the rail.** Position and lock two cage nuts far enough apart to stabilize the top and bottom of the ePDU when mounted on the rail. Insert the cage nuts with a flat-blade screwdriver (see Figure 18).
4. Locate the two clip feet and two screws (supplied). Position one mounting clip foot at a cage nut and secure the mounting clip foot to the rail with a screw. Repeat for the second mounting clip. Tighten the screws. Go to Step 8.

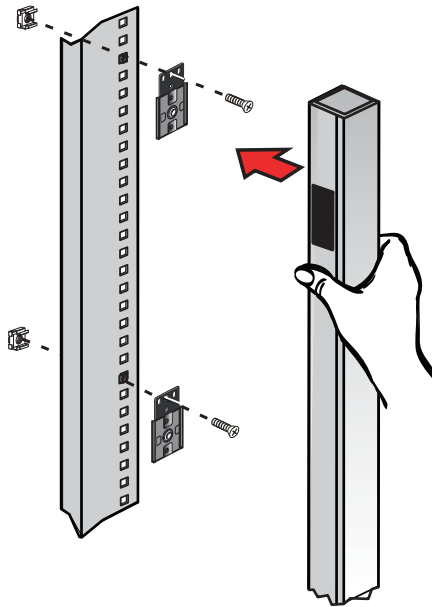

Figure 18. Attaching the Clip Feet and Cage Nuts

5. **ePDU away from the rail (offset).** Position and lock two cage nuts far enough apart to stabilize the top and bottom of the ePDU when mounted on the rail. Insert the cage nuts into the square rail hole with a flat-blade screwdriver.
6. Locate the two clip feet and two screws (supplied). Turn the straight part of the bracket 90° (see Figure 19).
7. Position one mounting clip foot at a cage nut and secure the mounting clip foot to the rail with a screw. Repeat for the second mounting clip. Tighten the screws.

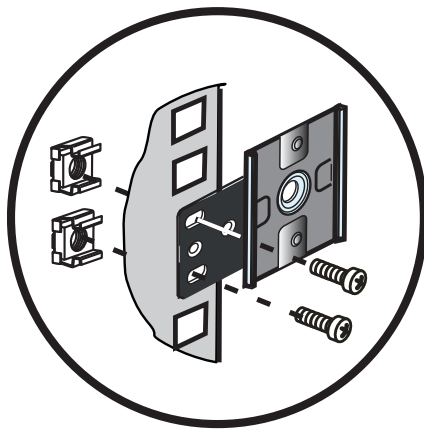

Figure 19. Attaching the Rotated Clip to the Rail

8. Snap the ePDU into the mounting clip feet. When you hear a clicking sound for each mounting clip foot, the ePDU is secure.
9. Continue to “Grounding the ePDU” on page 23 if you are installing a ground screw and grounding cable. Otherwise, go to “Network and Environmental Ports” on page 24.

Installing the Horizontal Models in a Rack Cabinet



NOTE For horizontal installations in square-hole racks, a cage nut must be installed in the selected mounting holes.

To install the ePDU models horizontally:

1. Select the desired height position to install the ePDU.



NOTE 1 The two black mounting brackets are pre-installed on unit.

NOTE 2 Make sure to select mounting holes that are parallel to each other so that the ePDU will be level when installed.

2. **For square-hole racks.** Install cage nuts in the appropriate mounting holes. Insert and tighten two M6 screws through the ears on each side of the ePDU.
3. **For all other racks.** Insert and tighten two M6 screws through the ears on each side of the ePDU (see Figure 20).

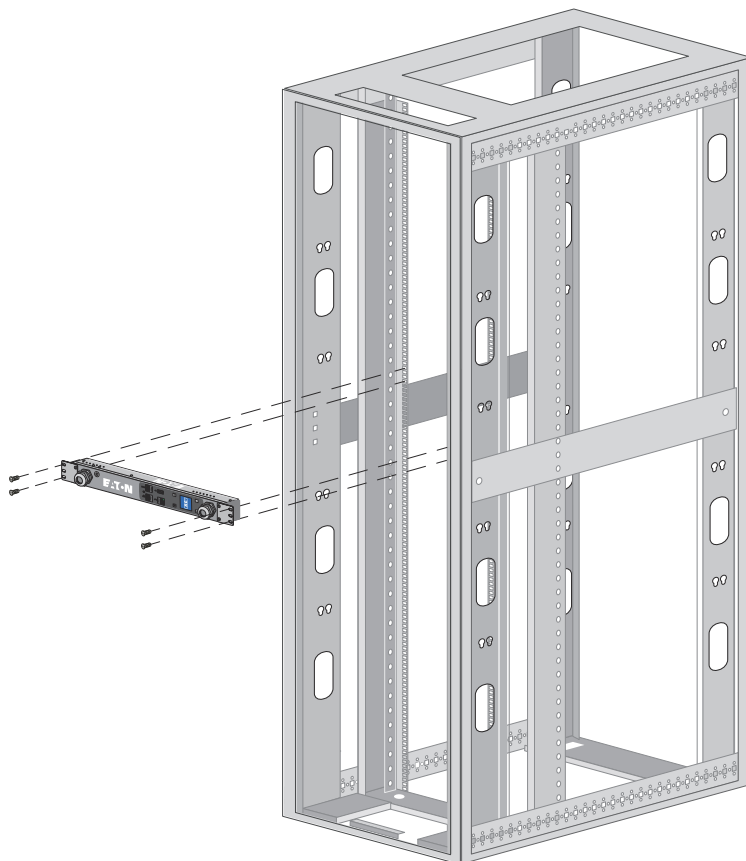

Figure 20. Installing Horizontal Models

4. Continue to “Grounding the ePDU” if you are installing a ground screw and grounding cable. Otherwise, go to “Network and Environmental Ports” on page 24.

Grounding the ePDU

i NOTE Grounding the ePDU is optional but recommended.

The ePDU is grounded through the input plug and an M6 ground screw is provided for auxiliary rack grounding. Conductors can be connected to the ground screw for functional grounding or bonding of ungrounded metal parts within the rack. The grounding screw is sized to safely conduct the fault current of the single largest output breaker. There is no paint on the screw or the chassis surface to ensure contact with bare metal instead of a painted surface. The ground symbol is impressed in the chassis above the earth bonding screw.

To ground the ePDU, connect a grounding cable (not supplied) from earth to the grounding screw shown in Figure 21 and Figure 22. The internal diameter of the ground strap ring is M6 (6 mm).

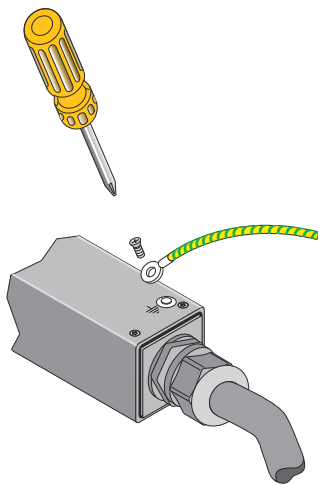

Figure 21. Grounding Screw Location for OU Vertical Models

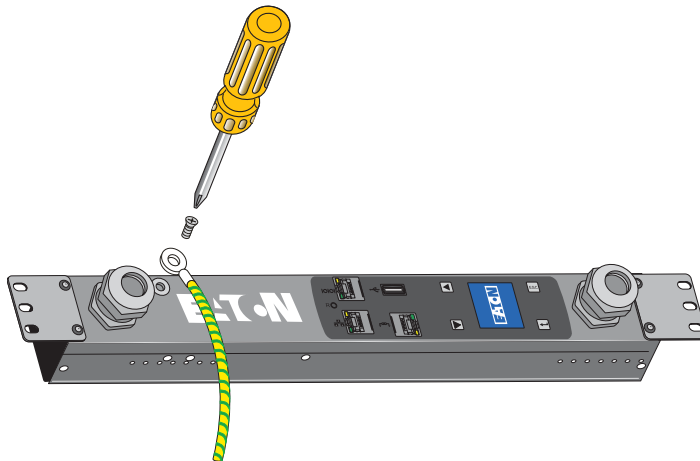

Figure 22. Grounding Screw Location for IL Horizontal Models

Network and Environmental Ports

The ePDU provides four types of ports for network connectivity and environmental monitoring.

- To connect the ePDU to a serial port on a computer, go to the next section, “Connecting to a Computer Serial Port”.
- To connect the ePDU to a 10/100 MB Ethernet-capable port and the Local Area Network (LAN), go to “Connecting to a LAN Ethernet Port” on page 25.
- To daisy-chain ePDUs, go to “Connecting Multiple ePDUs in a Daisy Chain” on page 25.
- To connect the ePDU to EMP equipment, go to “Connecting Optional Environmental Monitoring Probe Equipment” on page 27.

Connecting to a Computer Serial Port

Connecting the ePDU to a computer allows communication through a serial connection.

To connect the ePDU to a computer:

1. Verify that the computer has a communication program such as HyperTerminal, Telnet, or SSH.
2. Locate the DB9-to-RJ-45 cable (supplied).
3. Connect the RJ-45 end of the cable to the RS-232 connector on the front panel of your ePDU model (see Figure 23). Connect the DB9 end of the cable to the serial connector on the computer.

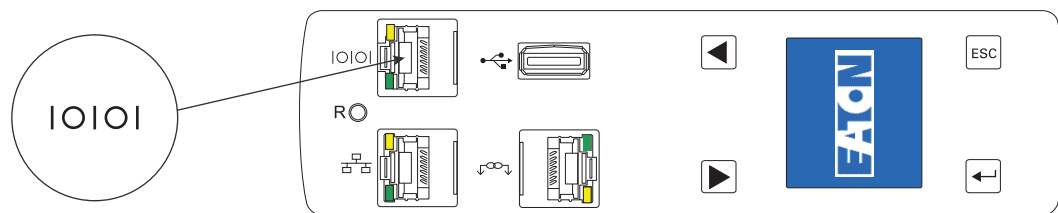

Figure 23. Connecting to a Computer Serial Port



NOTE

If your computer does not have a DB9 serial connector, obtain a DB9-to-USB converter. Follow the manufacturer’s instructions to install the converter cable device drivers and to connect the converter cable to your computer.

Connecting to a LAN Ethernet Port

Connecting the ePDU to a LAN provides communication through an Internet or Intranet connection. You can monitor the ePDU from any computer connected to the same network. (The network card is 10/100 MB-compatible.)

To connect the ePDU to a LAN:

1. Locate the Ethernet cable (supplied).



NOTE A short network cable is supplied in the network accessory pack. This cable is useful for setup or can be used where the network switch is in close proximity to the ePDU. Any standard network cable can be used if longer lengths are needed

2. Connect one end of the cable to the Ethernet connector on the ePDU (see Figure 24). Connect the other end of the cable to the Ethernet connector on the router (or other LAN device).

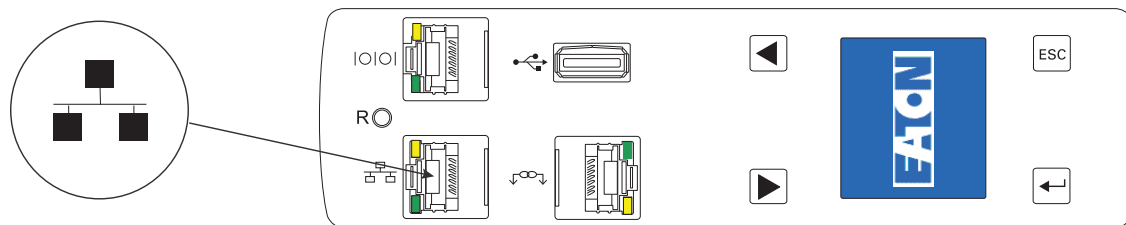

Figure 24. Connecting the ePDU to a LAN

Connecting Multiple ePDUs in a Daisy Chain

Two to four ePDUs can be chained together using an Ethernet cable between the Daisy Chain ports located on the front panel. Daisy chain uses Eaton's patented RS-485 daisy chain (strapping) technology. This allows access to the ePDU data of multiple ePDUs from the same network connection. One ePDU is defined as the Host. This is the ePDU with a connection to the network. The other ePDU (or ePDUs) are Device(s).

Configure the ePDUs using the LCD or the CLI interfaces. Monitor the ePDUs using the CLI interface or the Web interface.

To connect ePDUs in a Daisy Chain communication configuration:

1. Locate an Ethernet cable or cables (one cable is supplied).
2. How many ePDUs are you daisy-chaining?
 - If three or four, go to Step 3.
 - If two, go to Step 4.
3. Insert the Y splitter in the Daisy Chain connector of the middle ePDU or ePDUs as shown in Figure 25.
4. Connect one end of the cable to the Daisy Chain connector on one ePDU. Connect the other end of the cable to the Daisy Chain connector on the other ePDU or ePDUs as shown in Figure 25.



NOTE

Only one ePDU in a daisy-chained group can have a network connection through the Ethernet port. This ePDU is the Host and any connected ePDUs are Devices.

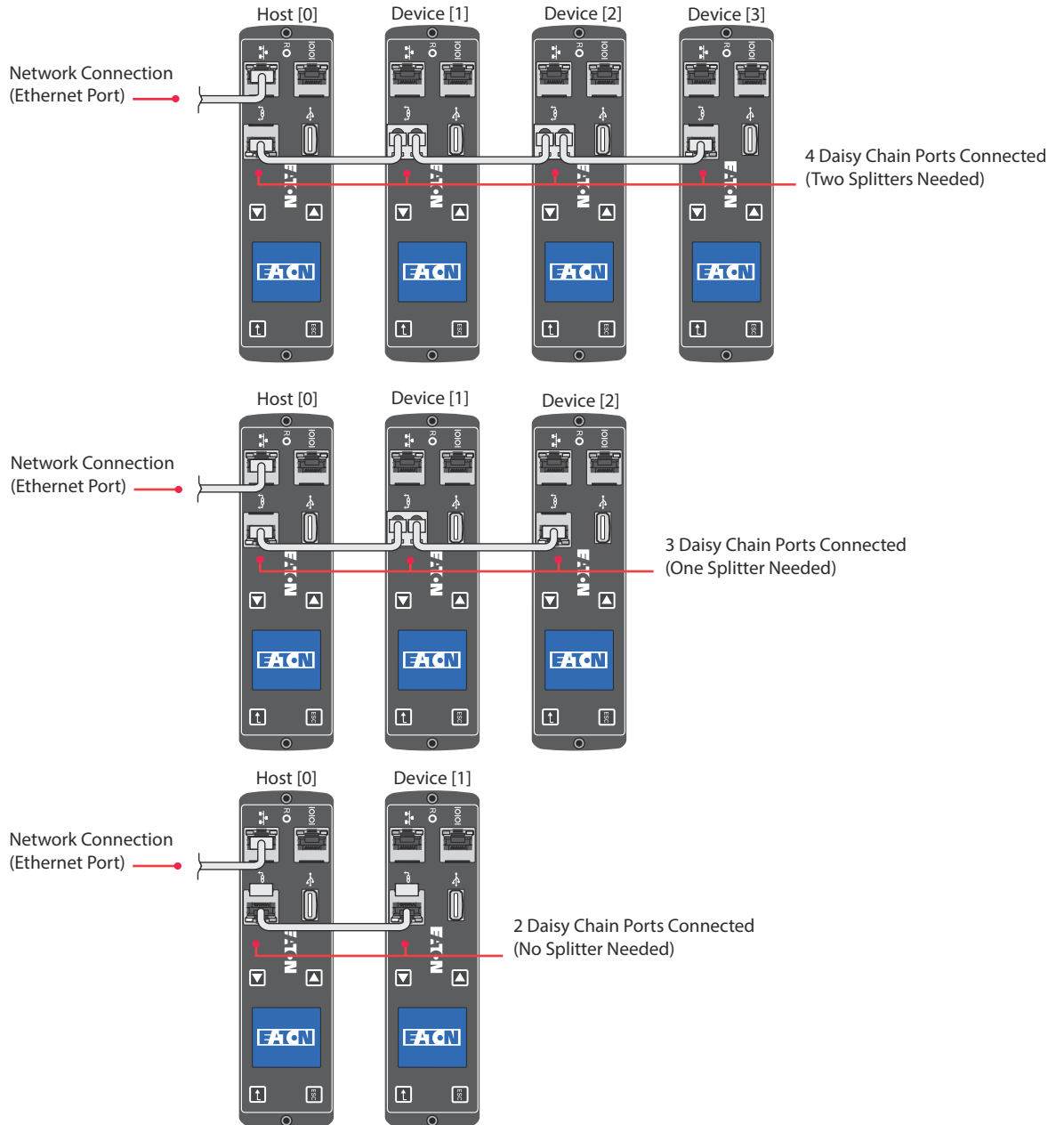

Figure 25. Locating the Daisy Chain Connector

5. Configure the ePDUs with either the LCD interface or the CLI interface.
 - To configure the ePDUs using the LCD interface, go to “Daisy Chain Submenu” on page 56.
 - To configure the ePDUs using the CLI interface, go to “Set Daisy Chain” on page 69.
6. Monitor the ePDUs with the CLI interface or the Web interface.
 - To monitor the ePDUs using the Web interface, go to “Web Interface Operation” on page 94.
 - To monitor the ePDUs using the CLI interface, go to “Get Daisy-chained ePDU to Supervise or Retrieve Communication Status” on page 67.

Connecting Optional Environmental Monitoring Probe Equipment

You can purchase optional EMP equipment to monitor temperature and humidity around the ePDU and to monitor the status of sensors.

You can install an optional EMP now or after completing the ePDU installation and startup. Optional EMP equipment can be installed without turning off power to the ePDU or the devices connected to it.



IMPORTANT

Follow all installation and operation safety information provided in the manufacturer’s instruction manual for the EMP equipment.

To install an optional EMP:

1. Locate the EMP and the Ethernet cable (supplied).
2. Refer to the manufacturer’s installation manual for instructions to connect the external contact inputs to the optional EMP for the external contact devices you plan to monitor.
3. Locate the Ethernet cable dedicated to the EMP. Connect one end of the cable to the RJ-45 connector on the EMP, then connect the other end of the cable to the serial connector on the ePDU (see Figure 26).

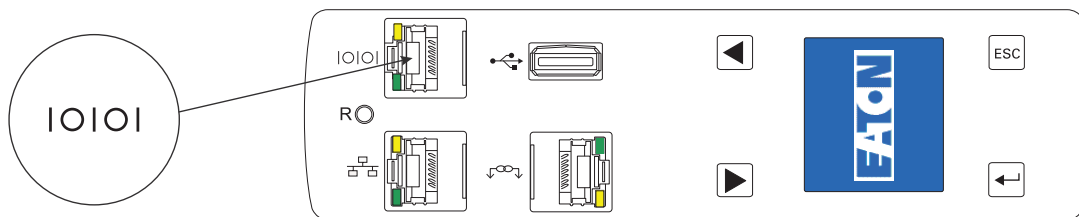

Figure 26. Connecting the EMP to the ePDU Serial Connector



NOTE

The maximum cable length is 2.99m (9.8 ft). If you install an EMP, the ePDU serial port must be dedicated to the EMP.

4. Use the mounting method appropriate to your installation to mount the EMP in a convenient location anywhere on the rack.
5. If desired, use cable ties to secure the Ethernet cable out of the way as needed.
6. On startup, the ePDU automatically recognizes the EMP.

Connecting the Output Devices

The ePDU outlets are available for connecting and monitoring devices such as workstations, servers, and switches. Connect a device you want to monitor to a power outlet on the ePDU with the power cord that comes with the device.



NOTE You may find it useful to document the connections you make.

To connect your devices:

1. Verify that each circuit breaker is in the On position.
2. **ePDUs with detachable power cords.** If the power cord is not connected, connect the power cord to the ePDU. Otherwise, go to Step 3.
3. Route the ePDU power cord toward a dedicated power source. If desired, use cable ties to secure the power cord as needed. If the power cord must exit the rack cabinet to connect to a power source, use the openings in the rack cabinet.



NOTE 1 Plug the ePDU into an appropriately rated outlet for its type.

NOTE 2 Do not replace or rewire the power cord.

4. Connect the power cord to a properly wired and grounded dedicated power source. The ePDU turns on and displays the Eaton startup screen while starting. After five seconds, the sequence of LCD screensaver screens for this ePDU model begin cycling.
5. Verify that no alarms display on the LCD. To resolve alarms, see "Maintenance and Alarms" on page 127.
6. Connect your output devices to the outlet outlets on the ePDU. Verify that each device is receiving power before connecting the next device.



NOTE To avoid large surge currents, connect the protected equipment to the outlets individually rather than as a group. You may want to include a delay for Switched and Managed models when setting up groups of outlets to start at the same time to avoid a large in-rush current.

7. Engage the lever for the IEC outlet grip plug retention mechanism on the side of the outlet from "O" to "+."



NOTE Only unplug the power cord when the grip plug retention mechanism is in the "+" position in an emergency.

8. Route all power cords neatly. If desired, use cable ties to secure the cords.

Operating the ePDU

See “Operation Overview” on page 28 for instructions to operate the ePDU, including starting and shutting down the equipment.

Chapter 4 Operation Overview

This chapter describes the Eaton Enclosure Power Distribution Unit (ePDU) G3 operation overview.

Operation Interfaces

The type of model you are using dictates the level of ePDU operation control you have. You can configure, manage, or monitor the ePDU through a local interface (onboard the ePDU) or through remote interfaces (through the network):

- **Configure (All except Basic).** Basic configuration is available for some settings through the LCD menu onboard the ePDU. Full configuration of all settings is available through the remote Web and Command Language Interpreter (CLI) interfaces.
- **Monitor (All except Basic).** You can monitor measurements using either the local or Web remote interfaces.
- **Manage (For Switched (SW) and Managed (MA) ePDUs only).** You can use the Web interface to monitor the ePDU and manage outlets and groups of outlets. Outlets that are in the same user-defined group can be turned on, turned off, rebooted, and scheduled to perform actions in a synchronized manner.

Local Operation Interface

The LCD provides information about the ePDU and connected devices using white text on a blue background. The LCD display flashes red when any alarm is active.

The LCD display orientation can be changed using an LCD or CLI setting. The display can be rotated 90°, 180°, or -90° (270°). See "Display Submenu" on page 43 or see Example 2 in "set command" on page 79 for more information.

LCD Display

The LCD display has three modes:

- **Screensaver Mode** (startup screen)
Screensaver mode cycles through a set sequence of screens that display current PDU values. Current values are refreshed every five seconds. The user cannot select a custom sequence of screens.
- **Energy Saving Mode**
This mode is activated manually. The backlight is turned off to conserve energy. The screen darkens. The screen reactivates when any button is pushed or when an active alarm occurs.
- **LCD Main Menu Mode**
The settings that display under each high level (main) menu depend on your ePDU model.

Status Display

When the screensaver is activated, it displays a set of up-to-date values. However, this set of values is not user-configurable. To selectively view values, navigate through the LCD interface using the buttons on the front panel.

For example, selecting ePDU from the Meter submenu and then selecting Total Input from the ePDU Meter submenu displays total input values for the ePDU. Figure 27 is an example of the display for a 1Ph ePDU.

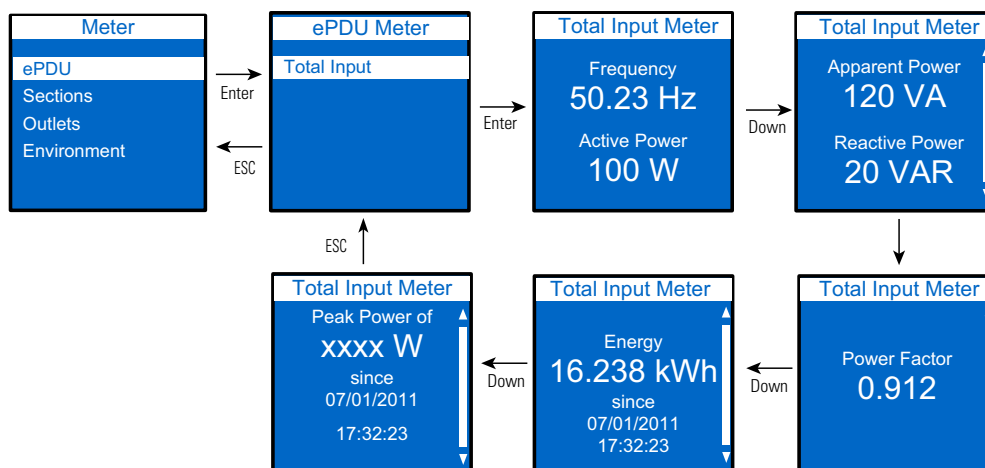

Figure 27. Example of Selected Value Display

Main Menu Display

The menu items are highlighted when they are selected. The resulting screens can include data displays, value setting options, or submenus. Figure 28 illustrates the highlighted Active Alarms LCD menu item selection.

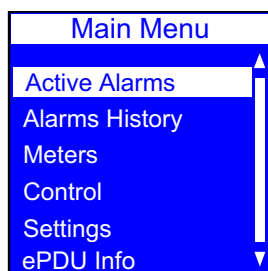

Figure 28. Menu Item Selection

See “LCD Interface Operation” on page 42 for detailed operation information.

Remote Operation Interfaces

You can communicate with the ePDU using the remote interfaces listed in Table 3.

Table 3. Remote Interfaces

Interface	Description	ePDU Connector	Cable (supplied)	Cabling Instructions
Web browser	ePDU management interface through an Internet Web browser*			
SNMP	Standard Internet protocol for managing devices on networks**	Ethernet connector	Ethernet cable	“Connecting to a Local Area Network Ethernet Port” on page 22
Telnet Command Line Interface (CLI)	Terminal emulation protocol for accessing the CLI via Ethernet to configure the eNMC module			
Console emulator CLI	Serial interface for accessing CLI directly from a computer	Serial connector ***	DB9-to-RJ-45 cable	“Connecting to a Computer Serial Port” on page 20

* Supports Microsoft® Internet Explorer® 8.0 and greater, Mozilla® Firefox®, Google Chrome™.

** Supports Simple Network Management Protocol (SNMP) v1, v2, and v3. Provides the ability to send traps, retrieve outlet specific data, set ePDU and outlet values, and notify of events through SNMP trap or e-mail alert.

*** If you install an optional EMP, you must dedicate the serial connector to the EMP. (The EMP Ethernet cable is supplied in the EMP shipping carton.)

Outlets and Circuit Breakers

A variety of outlet types are available for the Eaton ePDUs. Each ePDU model has a specific configuration of outlets. The configuration can be standard or customized to suit your needs.

The outlets are grouped in sets called sections. Sections are preset groups of individual outlets that you can identify and monitor through the interfaces that are available with your particular type of ePDU.

The outlets are color-coded and labeled, and if the model has circuit breakers, the circuit breakers that are associated with the outlets have corresponding labels (see Figure 29). (The “circuit breaker tripped” status is not reported.)

Outlets and sections of outlets can be managed through the Web Interface (see “Groups” on page 104, “Outlets” on page 105, and “User-Defined Group Definition” on page 113). You can see measurement readings using the local LCD interface.

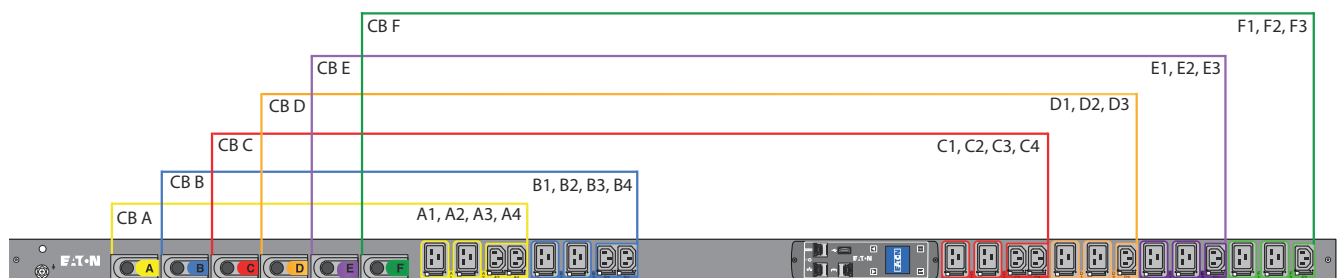

Figure 29. Outlet Groups and Circuit Breakers

Ports, Operation Buttons and LED Status Indicators

The Eaton ePDUs include communication and serial ports (also used for environmental monitoring), operation buttons, and status LEDs (see Figure 30). The ePDU front panel includes communication and monitoring ports, LED status indicators, and operation buttons. The ports and the associated LED indicators are described in the following Table 4.



NOTE

At startup, check the LED status display colors on the communication and monitoring ports to ensure that they are operating correctly.

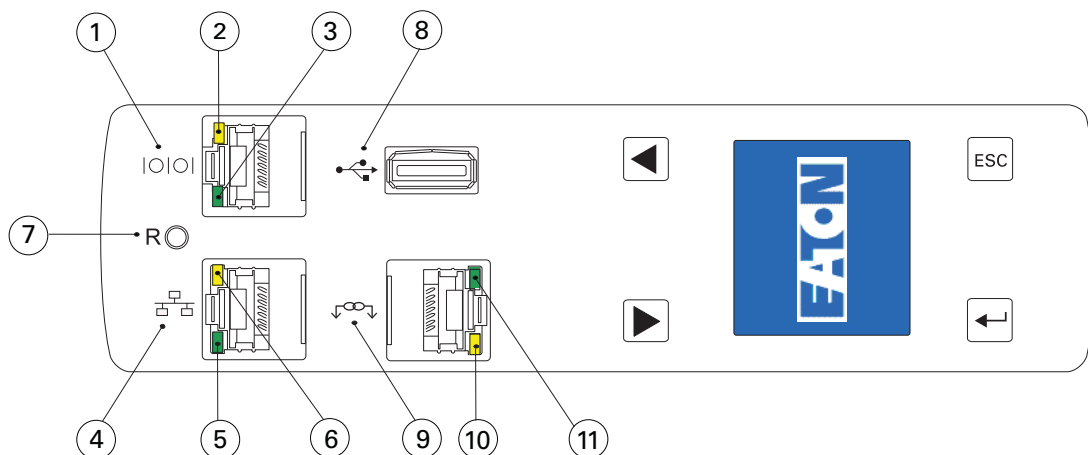

Figure 30. Communication and Serial Ports

Table 4. Communication and Environmental Monitoring Ports

Diagram Reference Number	Description
1	Serial or Environmental Monitoring (EMP) Port
2	Yellow Serial/EMP Port LED: RS-232 Operation and Activity Status OFF: No EMP connected FLASHING: EMP connected
3	Green Serial/EMP Port LED: ePDU Communication Status OFF: ePDU start-up in progress FLASHING: eNMC module operational
4	Ethernet 10/100 Base-T Port
5	Green Ethernet Port LED: Operation Transfer Rate Status OFF: Port operating at 10 Mbits/s ON: Port operating at 100 Mbits/s
6	Yellow Ethernet Port LED: Connection and Transmission Activity Status OFF: ePDU not connected to the network ON: ePDU connected to the network, but no activity FLASHING: Port is sending or receiving (transmission active)
7	Reset Button NOTE To restart the eNMC, insert a probe and press the button for 3 seconds (or until the LCD goes blank). This does not reset power to the outlets.
8	USB Port: Used for firmware upgrade and configuration file download/upload
9	Daisy Chain Port
10	Yellow Daisy Chain Port LED: Transmission Activity Status FLASHING: ePDU is transmitting data
11	Green Daisy Chain Port LED: Role Assignment in Communication Protocol ON: Device FLASHING: Host

Operation Concepts

This section provides information describing the following ePDU operation concept:

- User login and access policy

For more information, see “Access Privileges” on page 99.

User Login and Access Policy

The web interface is protected by a login and a password. The ePDU Network Management and Control (eNMC) module manages up to eight users and one Administrator.

A user is defined by:

- Name identifier (login)
- Password (minimum of five characters)
- Assigned access rights (Read Only, Read/Write, Read/Write/Control, No Access)
- List of groups of outlets to which the user has access



NOTE At a minimum, users need Read-Only access rights to access the Web pages.

When a user accesses the Web interface, the system prompts for a login and password. The login and password for the administrator and for each user are hashed using a one-way hash algorithm. If the login and password match and the assigned user rights do not restrict access, the user can access the Web interface.



IMPORTANT

Users should always terminate sessions by clicking the logout link in the top right-hand corner of the Web interface page.

Common Operations

Starting the ePDU



NOTE The Eaton ePDUs have no power switch.

To start up the ePDU:

1. For ePDUs with detachable power cords: If the power cord is not connected, connect the power cord to the ePDU, then connect the power cord to a power source. Otherwise, go to Step 2.



NOTE 1 Plug the ePDU into an appropriately rated outlet for its type.

NOTE 2 Do not replace or rewire the power cord.

2. Verify all circuit breakers are in the On position.

**IMPORTANT**

To power cycle the Eaton ePDU, remove the power cord from the power source and then plug it back in.

Shutting Down the ePDU

To shut down the ePDU:

1. Shut down the connected devices according to the manufacturer's recommended shutdown sequence.
2. Turn each circuit breaker to the Off position.
3. To remove power from the ePDU completely, disconnect the ePDU power cord from the power source.

Restarting the ePDU Network Management and Control (eNMC) module

You can restart the communications module using either a hardware or software method.

**IMPORTANT**

Restarting the eNMC module will not affect the output power or the connected equipment.

A software restart is triggered from the Serial interface or Web interface upon user action (see Figure 31). This method is typically the better choice because all current settings in the communications module file system are saved before restarting.

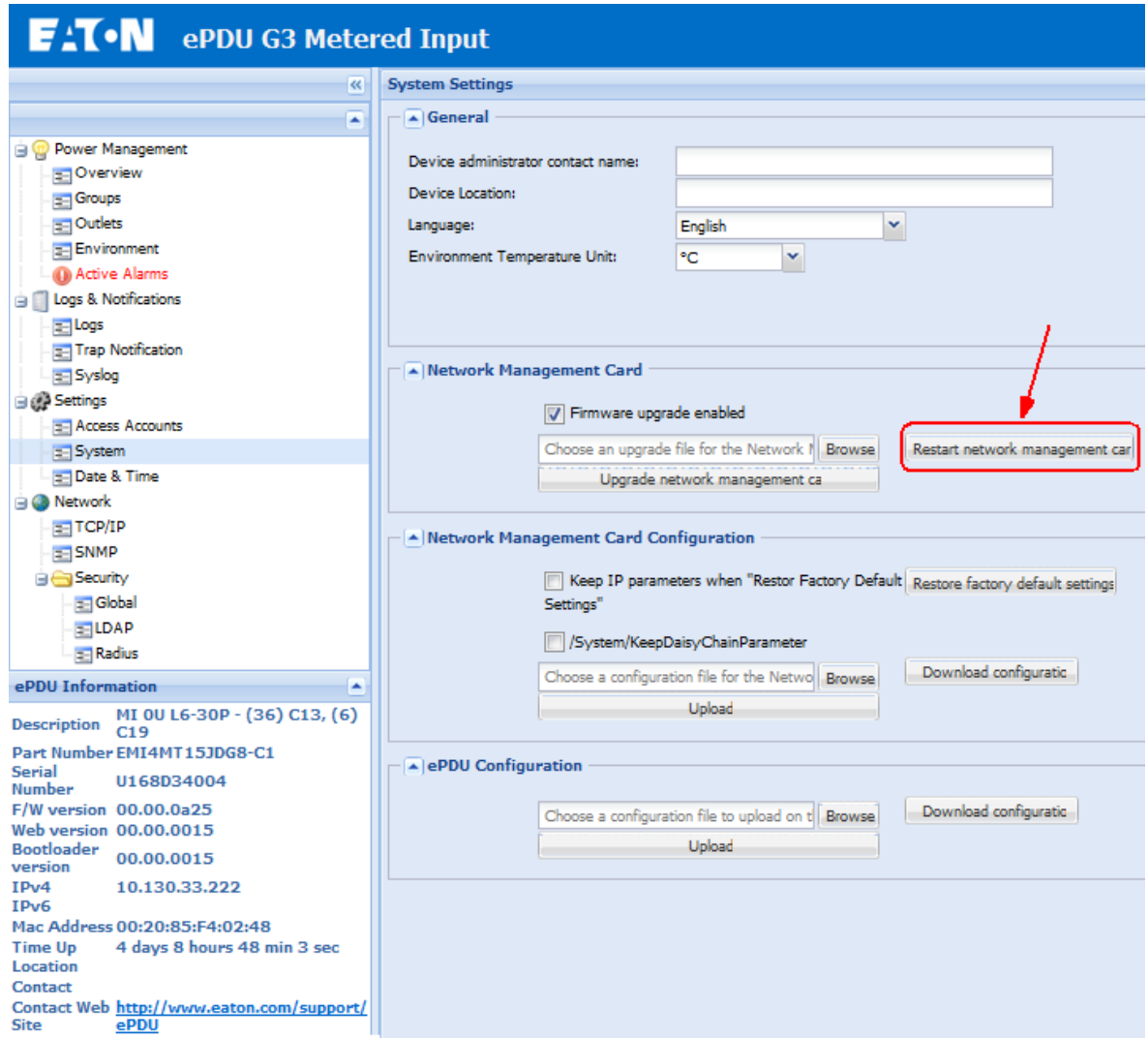

Figure 31. Reset the eNMC Module from the Web Interface

For a hardware restart, locate the Reset opening (labeled R) on the ePDU (see Figure 32). Insert a probe, press the recessed button, and retract the probe. This method is not necessarily the best choice because the communications module does not force the system to save the parameters in the file system before restarting.

The H/W restart button does not affect ePDU outlet status. The energy consumption is still recorded during the reboot of the eNMC module.



NOTE

When using a hardware restart to restart the eNMC module, there is no mandatory check to ensure that the file system parameters are saved before restarting.

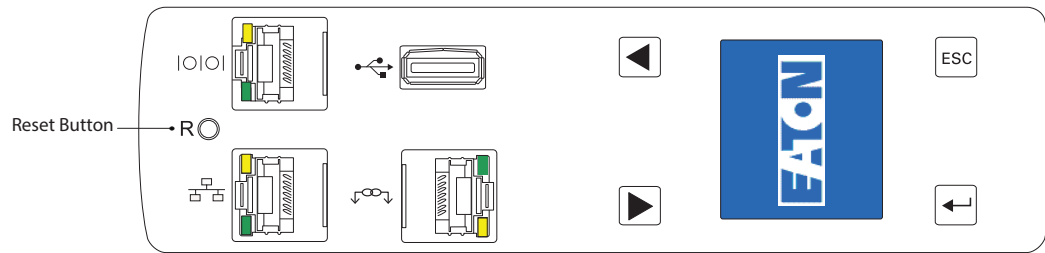

Figure 32. Reset Button

Chapter 5 Network Communication Configuration

The Eaton Enclosure Power Distribution Unit (ePDU) G3 automatically collects the network communication configuration settings (IP parameters) from the server by default. When the ePDU is not connected to the network, it continuously attempts to connect. If DHCP is enabled on your network, G3 automatically collects the network communication configuration settings.

When the connection is established, ePDU network configuration settings become available using the command line interface (CLI) on a serial interface. Access to the CLI is provided using a terminal emulation program, such as Telnet, HyperTerminal®, PuTTY or TeraTerm.



NOTE In order to use Telnet, you must have a network connection already established.

The ePDU defaults to using Dynamic Host Configuration Protocol (DHCP) when delivered. If you are unable to connect to the ePDU through the network connection with this default address, change the IP address using the LCD or through the CLI using a terminal emulation program.

The network connection automatically receives an IP address through the DHCP if available on the network. If DHCP is enabled but a DHCP server is not available, the eNMC module will use the last-used IP address setting. Alternately, it is possible to set a static IP address by using either the LCD menu or a serial connection command line interface (CLI).

The default settings are:

- DHCP: Enabled
- IP Address: 192.168.123.123
- Subnet Mask: 255.255.255.0
- Gateway: 192.168.123.1
- Username: admin
- Password: admin



NOTE If you use the default IP address and are able to make a direct connection, you could use Telnet to change the settings to some other fixed values.

LCD — DHCP

1. The ePDU defaults to DHCP enabled when delivered.
2. Connect to a network that has a DHCP server and wait 20 seconds before the eNMC module reboots with the new IP address.
3. Obtain the IP address from the LCD home screen (see Figure 33).



Figure 33. LCD Home Screen

LCD— Static IP address

- 1. Disable DHCP (see Figure 34).

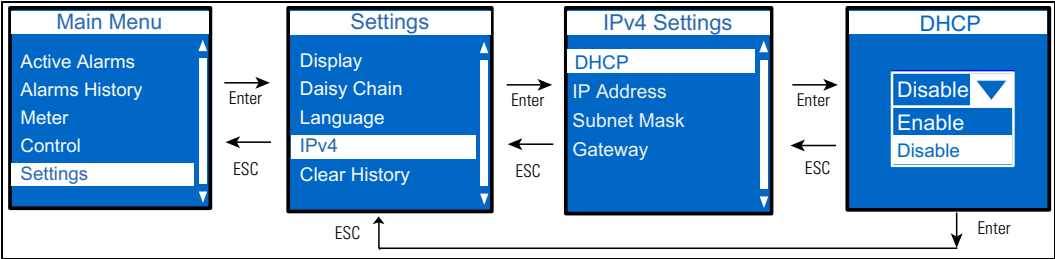

Figure 34. Disable DHCP

- 2. Set the static IP address (see Figure 35). Wait 10 seconds.

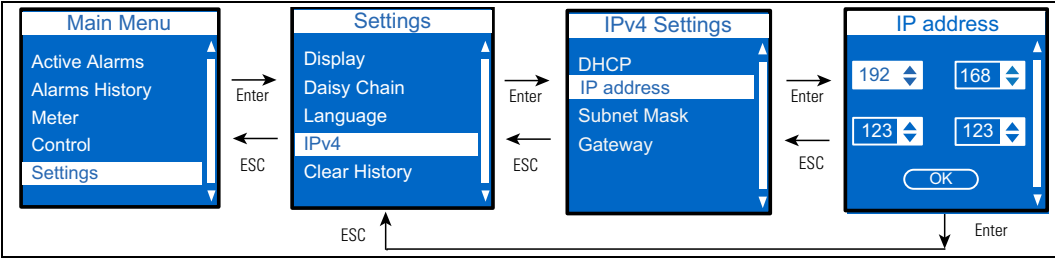

Figure 35. Set the Static IP Address

- 3. After 10 seconds, use the reset button to restart the eNMC module and apply the new settings (see Figure 36).

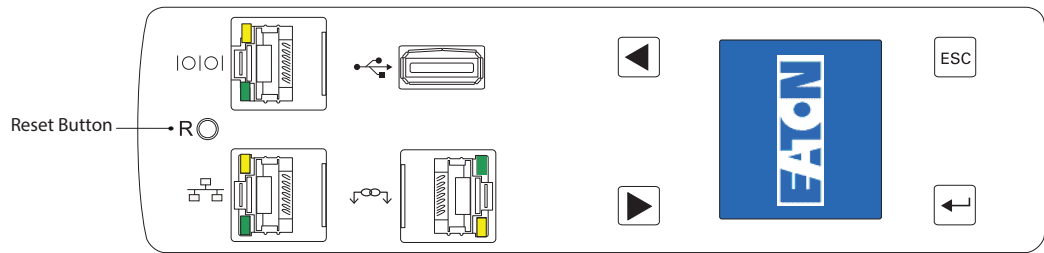

Figure 36. Reset Button

Serial connection — Static IP address

Use the RJ45-to-DB9 serial cable that is provided to connect the computer to the ePDU. If your computer does not have a DB9 (RS-232) connector, a USB-to-RS-232 adapter can be purchased separately. Access the CLI using a terminal emulation program such as HyperTerminal, PuTTY, or TeraTerm.

To set up the serial port using your selected terminal emulation program, use the following settings:

- Bits per second: 9600
- Data bits: 8
- Parity: None
- Stop bits: 1
- Flow Control: None

After establishing a serial connection, perform the following steps:

1. In the terminal emulator session window, enter the default user name (admin) at the login prompt. For example:

```
Enter Login: admin
Enter Password:
```
2. Type admin (default) at the password prompt. Press Enter. The CLI uses a "get" command to return the value of a setting and a "set" command to change the value of a setting. For example:

```
PDU#0>set System.Network.DHCP 0
PDU#0>get System.Network.DHCP
0
```
3. Type set System.Network.DHCP 0 and press Enter to modify the value (0 = disabled and 1 = enabled). For example:

```
PDU#0>set System.Network.DHCP 0
0
```
4. Set the IP address to a value provided by your system administrator.

```
PDU#0>set System.Network.IPAddress xxx.xxx.xxx.xxx
xxx.xxx.xxx.xxx
```
5. If necessary, set the network Subnet Mask to the value required by your system administrator.

```
PDU#0>set System.Network.IPMask 255.255.yyy.yyy
```



```
255.255.yyy.yyy
```

- Set the network Gateway to the value required by your system administrator.

```
PDU#0>set System.Network.IPGateway zzz.zzz.zzz.zzz
```

```
zzz.zzz.zzz.zzz
```

- Wait 10 seconds. Use the reset button to restart the eNMC module and apply the new settings.

**NOTE**

You can also connect up to four ePDUs together using the Daisy Chain port and an RJ-45 splitter (provided). This enables multiple ePDUs to communicate over one Ethernet port.

**NOTE**

If you choose not to use the procedure to configure the communications module without the DHCP server installed, you can connect to the ePDU using the default address: ***http://192.168.123.123***

Verify Web Operation After Configuration

To verify the communications module is operational and that you can access the Web interface:

- Open a Web browser.
- Enter the IPv4 or IPv6 address in the address bar in the following format:
http://<IPv4 address> or **http://<IPv6 address>**
- When the user authentication pop-up dialog displays, type **admin** in the User name field and **admin** in the Password field.
- The home page opens with the ePDUOverview page.

Chapter 6 LCD Interface Operation

This chapter contains operation information for the Eaton PDUs, including:

- LCD display and control button functions
- Menu selections



NOTE The LCD language is configurable. See language settings in “Language Submenu” on page 59.

LCD Display and Control Buttons

The ePDU has a four-button, graphical LCD display (see Figure 37). Use the control buttons to change the screen display, retrieve specific performance data, or change configuration values. The display view can also change automatically. For example, the display changes to show active alarms as they occur, or particular displays update due to a change in operating state.

A backlight is used to light up the display with white and blue:

- The backlight turns off automatically when no button has been pressed for 15 minutes and there is no active alarm.
- Any active alarm will cause the backlight to turn on automatically.





A red blinking background indicates that an alarm is active.



Figure 37. LCD Display

Table 5 summarizes how to use the control buttons.

Table 5. Control Buttons

Button	When on the Main Menu	When in Screensaver mode	When in Menu mode
	Returns to the Start-up screen.	Returns to the previous display screen before entering the screensaver mode.	Returns to the previous display screen.
	Opens the selected menu. NOTE: When menu items are highlighted, they are selected.	Returns to the previous display screen before entering the screensaver mode.	Signals that you want to set the values as displayed on the screen. NOTE: On information screens, this button has no action.
 	Scrolls up or down through the list of menu items.	Returns to the previous display screen before entering the screensaver mode.	Scrolls up or down to the next screen or value.

Operation Mode

Screensaver Cycling Sequence

The screensaver displays automatically after 30 seconds of inactivity from the start-up screen, a menu, or a submenu. Values are reset every five seconds. The screensaver displays data in a preset 1Ph cycle (Figure 38) or 3Ph cycle (Figure 39). These cycles are not user-configurable.

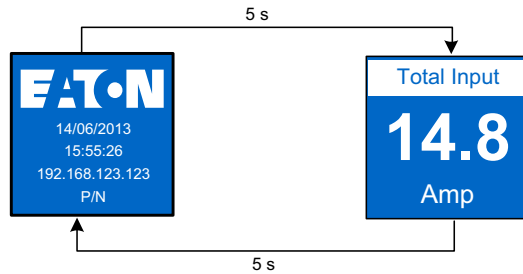

Figure 38. 1Ph Screensaver Cycle

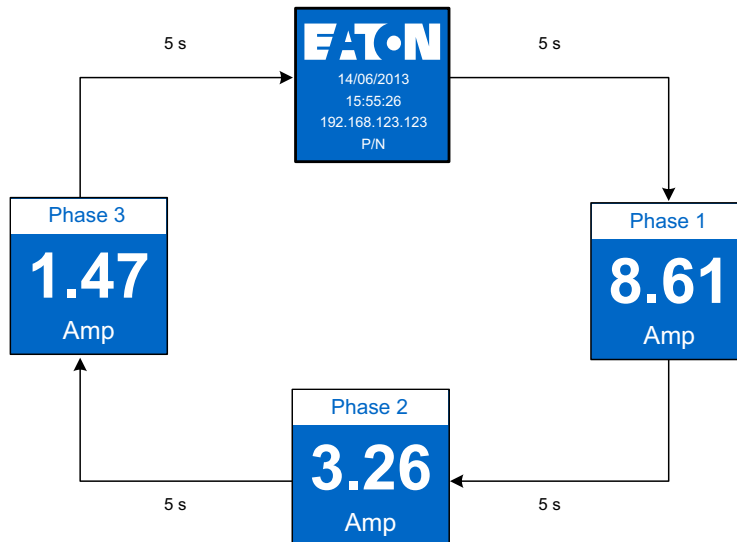

Figure 39. 3Ph Delta-configured Screensaver Cycle

Startup Screen

When the ePDU powers up, the Startup screen displays (see Figure 40). Press **ENTER** to go to the Main Menu.



Figure 40. Startup Screen

Password Protected Menus

Both Control and the Settings menus can be password-protected. This locks out the menus to any user who does not know the password.

Password configuration can only be done through the Web interface and the CLI menu.

Figure 41 illustrates the sequence to enter a password for a locked menu.

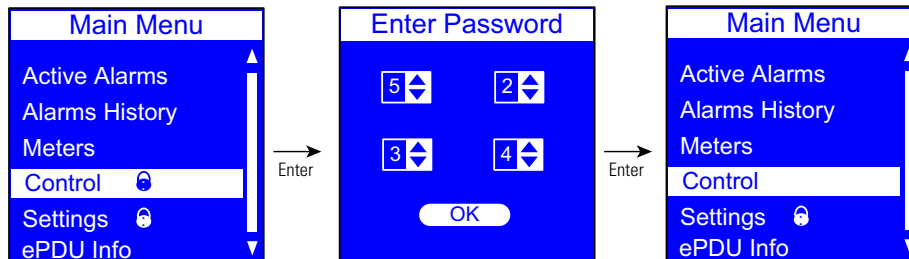

Figure 41. Password Protected Screens

Main Menu Selections

The ePDU menu selection hierarchy provides useful performance information, alarms, ePDU identification, and configuration settings (see Figure 42). The available menu items are illustrated in a menu hierarchy in Figure 43.

- Use the scroll buttons to select a menu item from the Main Menu.
- Selected menu items are highlighted and display as blue text on a white bar.
- Press **ENTER** to go the selected menu item.
- Press **ESC** from the Main Menu to return to the Startup Screen.



NOTE

The Control Menu is not available for Metered Input (MI) and Metered Outlet (MO) ePDUs.

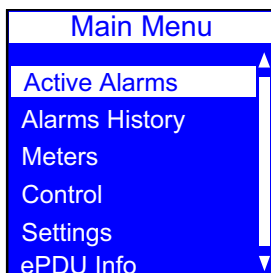
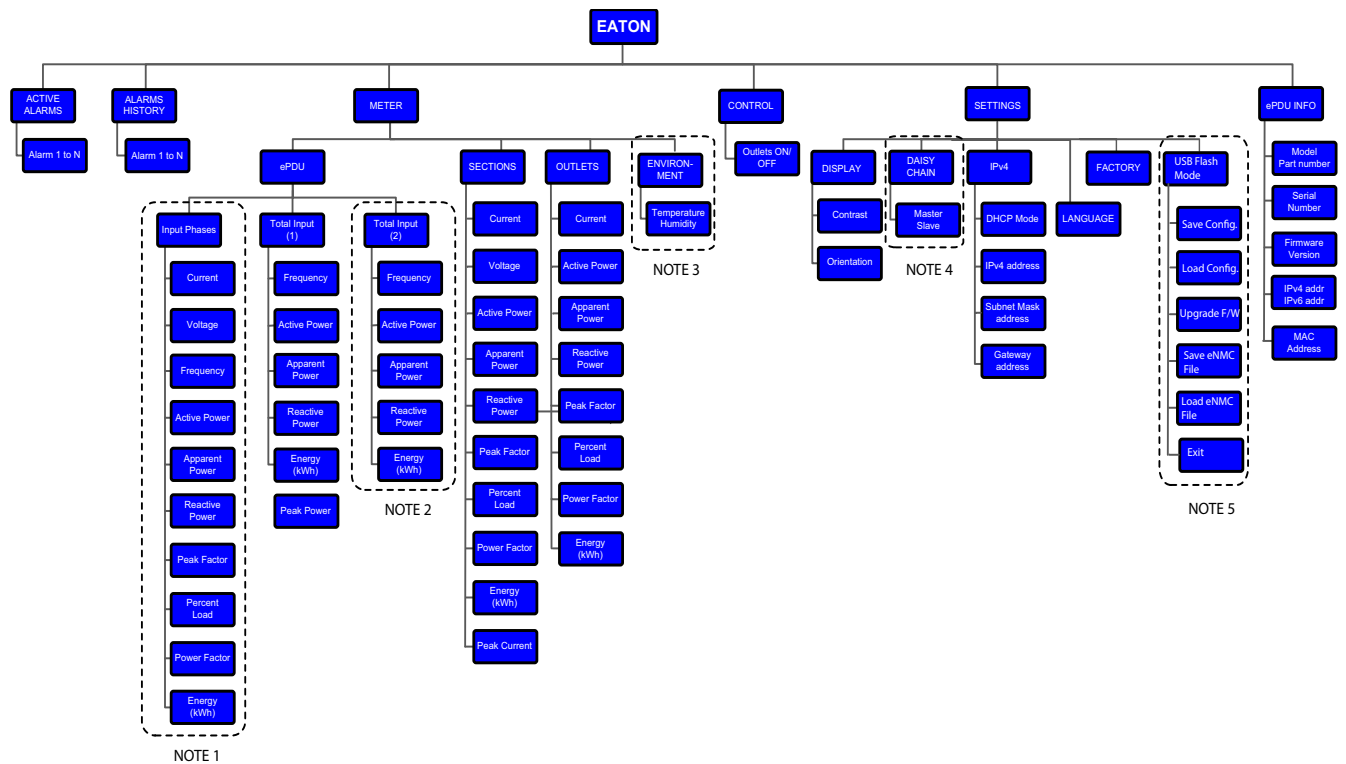

Figure 42. Main Menu Selections



NOTE 1 These submenus are only available for 3Ph input ePDUs.

NOTE 2 These submenus are only available for dual input ePDUs.



NOTE 3 This menu and submenu are only available if an EMP is connected.

NOTE 4 This submenu is only available for Host ePDUs when a daisy-chained configuration is used.

NOTE 5 This submenu is only available if a USB flash drive is detected.

Figure 43. ePDU Menu Hierarchy

Different sets of menus display depending on the type of topology you are managing or monitoring.

Table 6 shows LCD menus that are valid for ePDU topologies.

Table 6. Menus Available for ePDU Topologies

Models	Active Alarms	Alarm History	Meter ^{see NOTE 1}						Settings	ePDU Info
			ePDU			Sections	Outlets	Control		
			Input Phase	Total Input (1)	Total Input (2)					
Basic (BA)	—	—	—	—	—	—	—	—	—	—
Metered Input (MI)	•	•	NOTE2	•	—	•	—	—	•	•
Metered Outlet (MO)	•	•	NOTE2	•	—	•	•	—	•	•
Switched (SW)	•	•	NOTE2	•	—	•	—	•	•	•
Managed (MA)	•	•	NOTE2	•	—	•	•	•	•	•

NOTE 1 The **Meter > Environment** menu is only available if an Environmental Monitoring Probe (EMP) is attached.

NOTE 2 The Input Phase menu is available if the ePDU has multiple phases.

NOTE 3 The Total Input (2) menu is available if the ePDU has multiple inputs

Active Alarms Menu

The Active Alarms menu filters and displays only active alarms for the ePDU. Active alarm screens have priority over other screens. When an alarm occurs, the Active Alarms screen replaces the current screen and the backlight blinks in red and white (see Figure 44). Up to 100 active alarms can display.

On the Main Menu, scroll up or down to highlight **Active Alarms**. Press **ENTER** to display the first active alarm screen. Scroll up or down if needed to view active alarm data. When you finish your review, press **ESC** to return to the previous menu. If the backlight was blinking red to indicate an active alarm, the backlight returns to normal.

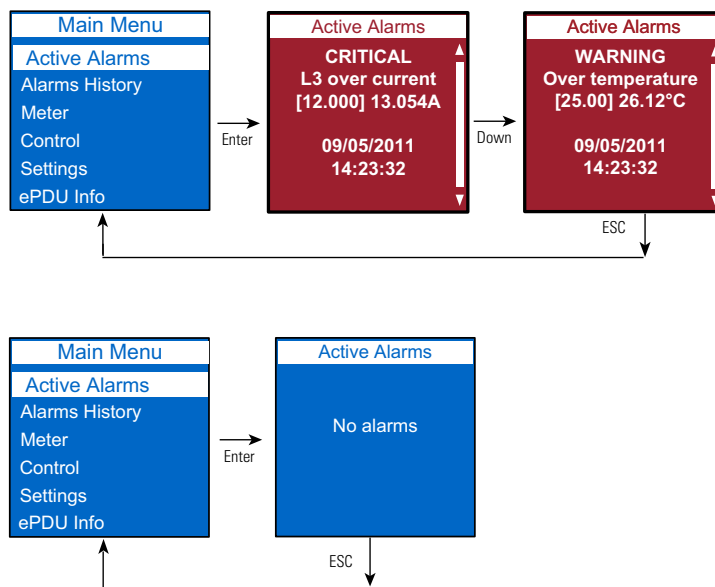

Figure 44. Example Active Alarm Displays

Alarms History Menu

The Alarms History menu allows you to scroll through the last 50 logged alarms, beginning with the most recent alarm. The Alarms History screens contain the type of alarm, the date (*MM/DD/YYYY*), and time (*hh:mm:ss*) when the alarm occurred (see Figure 45).

On the Main Menu, scroll up or down to highlight **Alarms History**. Press **ENTER** to display the most recent alarm in the history log. Scroll up or down to view the alarms. When you finish your review, press **ESC** to return to the previous menu.

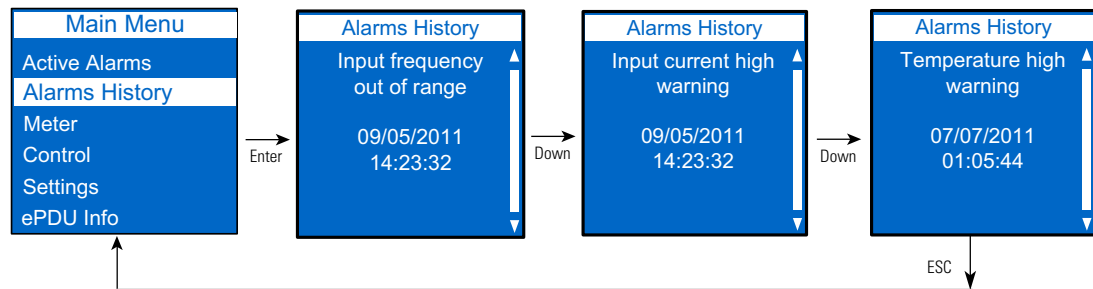

Figure 45. Example Alarm History Displays

Meter Menu

The Meter menu provides measurement data for the following submenus:

- ePDU
- Sections (not available for sections that do not have current measurement)
- Outlets (not available for MI and SW ePDUs)
- Environment (only available if an EMP is installed)

On the Main Menu, scroll up or down to highlight **Meter**. Press **ENTER**. Scroll up or down to select a submenu and press **ENTER** to display the submenu options. Press **ESC** to return to the previous menu.

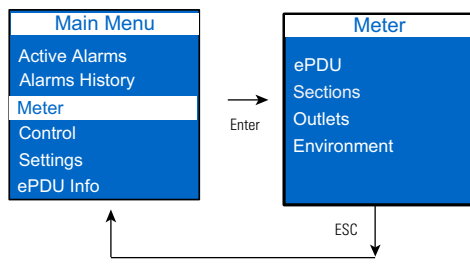

Figure 46. Example Meter Menu Display



NOTE The measurement data for each screen is refreshed every two seconds.

ePDU Submenu

These screens display Total Input data measurements for ePDUs. In addition to Total Input measurements, you can view Phase Input data measurements for 3Ph, split-phase, and dual input ePDUs. Depending on the ePDU electrical topology, different ePDU measures will display in the Total Input and the Input Phase meter screens.

Table 7 shows which measures will be present:

Table 7. Measures for Total Input and Phase Input Meter Screens

Measure	Total Input	Wye-wired Input Phase	Delta-wired Input Phase
Frequency	•	—	—
Voltage	—	•	•
Current	—	•	•
Percent Load	—	•	•
Active Power	•	•	—
Crest Factor	—	•	•
Apparent Power	•	—	—
Reactive Power	•	—	—
Power Factor	•	—	—
Energy	•	—	—
Peak Power	•	—	—

Total Input Meter Data

On the Meter menu, scroll up or down to highlight ePDU. Press **ENTER** to display the Total Input submenu for your 1Ph, 3Ph, split-phase, or dual input ePDU. Press **ENTER** again to see Total Input meter data measurements. Scroll up or down to review other Total Input meter data measurements. After you review the data, you can press **ESC** to return to the Input Meter menu and select L1, L2, or L3 to see Phase Input measurements. Press **ESC** to return to the previous menu.

For example, Figure 47 shows a total input display for 1Ph ePDUs.

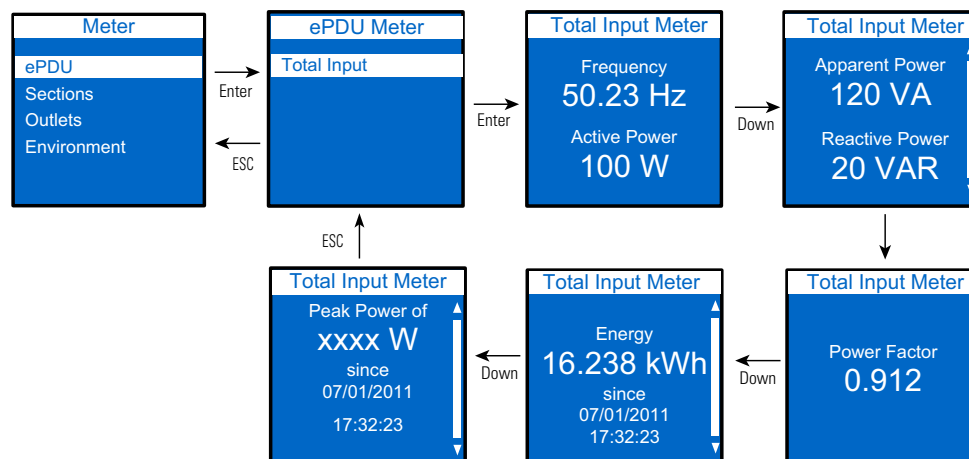

Figure 47. Example 1Ph Total Input Display



NOTE The **Total Input > Input Meter** selection screens will be different for 1 Ph, 3 Ph, dual input, and split-phase ePDUs.

Figure 48 shows an input phase display for wye-wired 3Ph ePDUs.

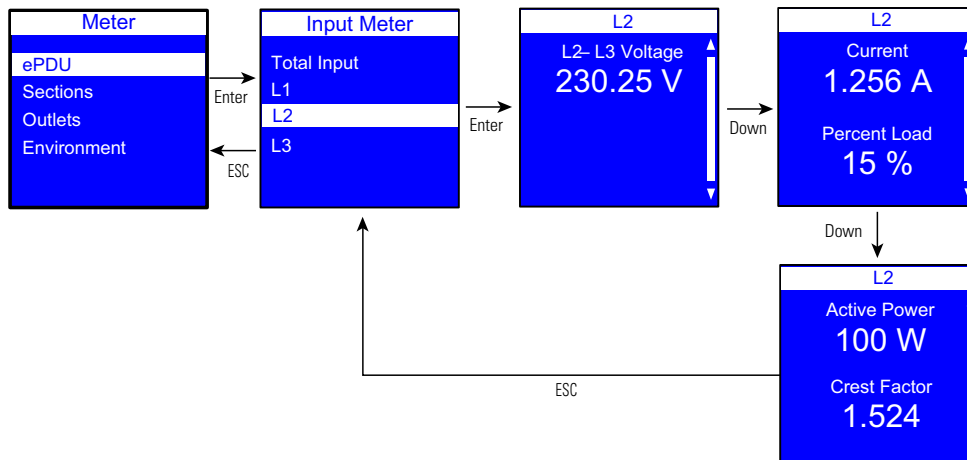

Figure 48. Example 3Ph Input Phase (wye-wired) Display

Sections Submenu

Section measurements include voltage data for all ePDU sections. Other sections measurements are only available on ePDUs that have current measurement capabilities (see Figure 49).

On the Meter menu, scroll up or down to highlight **Sections**. Press **ENTER** to display the Sections submenu. Scroll up or down to review the data for your selection. After you review the data, press **ESC** twice to return to the previous menu.

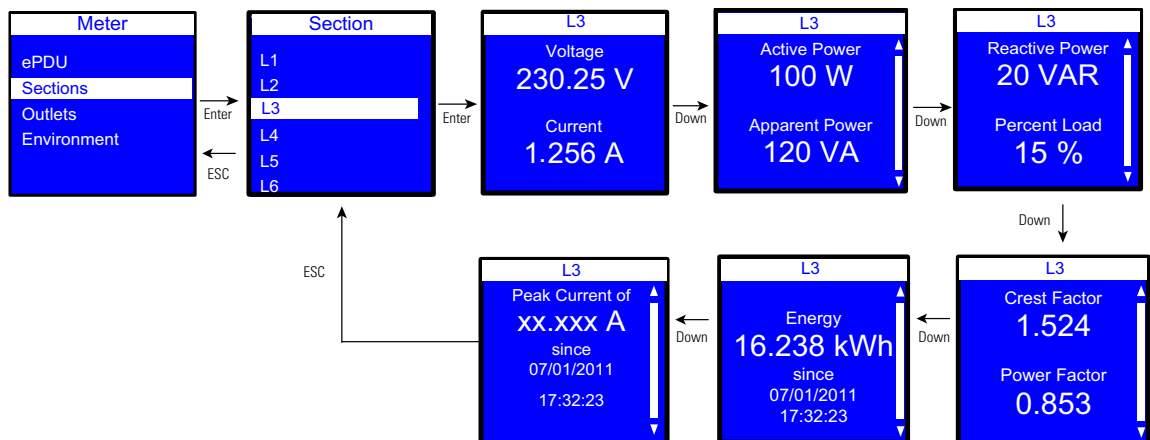

Figure 49. Example Section Submenu Display

Outlets Submenu

On the Meter menu, scroll up or down to highlight **Outlets**. Press **ENTER** to display the Outlets submenu. Scroll up or down to review the data for your selection. After you review the data, press **ESC** twice to return to the previous menu (see Figure 50).

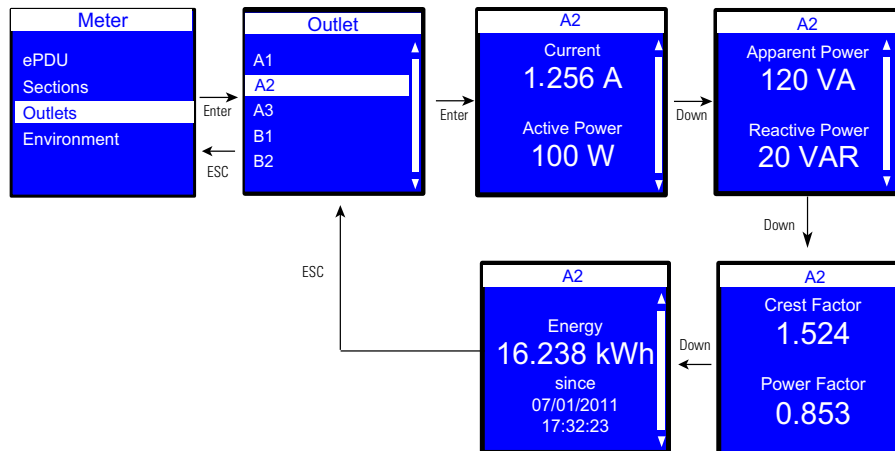

Figure 50. Example Outlets Submenu Display

Environment Submenu

The Environment submenu provides temperature and humidity data for the EMP. This menu is only available if an EMP is installed.

On the Meter menu, scroll up or down to highlight **Environment**. Press **ENTER** to display the Environment submenu. Press **ENTER** to review the data for your selection. After you review the data, press **ESC** to return to the previous menu. (Contact closures are not displayed on the LCD.)

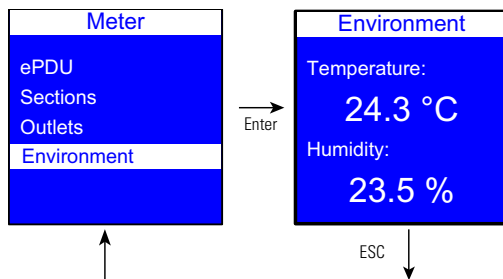

Figure 51. Example Environment Submenu Display

Control Menu

For Switched (SW) and Managed (MA) ePDUs only. On the Main Menu, scroll up or down to highlight **Control**. Press **ENTER**. Scroll up or down to see a list of outlet group IDs. Select an outlet group. The On/Off drop down list displays. Select On or Off. The selected state of the outlet displays. Scroll up or down to see other lists of outlet group IDs (if available). Press **ESC** to return to the previous menu (see Figure 52).

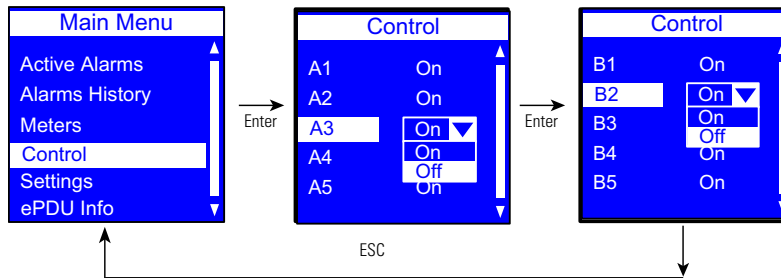

Figure 52. Example Control Submenu Display

Settings Menu

The Settings menu provides user configuration options. Only the available options display, depending on the assigned user privileges.

There are five standard Settings submenus and one optional submenu:

- USB Flash mode (only available if the USB device is detected)
- Display
- Daisy Chain
- Language
- IPv4
- Factory

On the Main Menu, scroll up or down to highlight **Settings**. Press **ENTER**. Scroll up or down to select a submenu and press **ENTER** to display the submenu options. Press **ESC** to return to the previous menu.

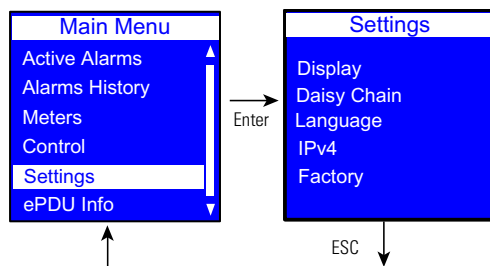

Figure 53. Example Settings Menu Display

USB Flash Mode Submenu

The “USB Flash Mode Submenu” displays in the Settings menu when a USB device is detected in the USB port. The menu selection does not display when the USB device is removed.

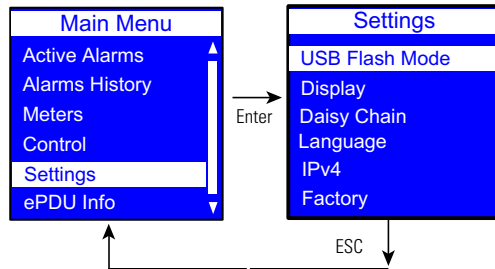

Figure 54. Example Settings USB Flash Mode Menu Display

Save User Configuration Data Files to the USB

This LCD menu option allows you to save configuration files to the USB flash drive.

After this step is completed, the following files will exist on the USB device:

- eNMC/config/ConfigurationData.xml - Contains all network and communication-related settings. This can be saved from and loaded to any ePDU G3 when replicating configurations regardless of part number.
- eNMC/config/ConfigurationPdu.xml - Contains all the user-configurable settings related to the ePDU itself such as voltage and current thresholds, customized naming, and outlet control parameters. The structure of this file depends on the part number so that it cannot be duplicated from PNx to PNy.

To save the user configuration files to the USB flash drive:

1. Make sure eNMC module is power ON.
2. Insert a USB device in the USB port. Verify the USB flash disk contains the eNMC/config directory located at root of USB flash disk (see Figure 56).
3. Click **OK** when the USB is detected and click **Enter** to return to the Main Menu.
4. Under Settings, select USB Flash Mode.
5. The eNMC module restarts. (If there is no action within one minute, the eNMC module exits the USB Flash mode. Unplug and replug the USB flash disk to access this menu again.)
6. Select Save Config (see Figure 55).

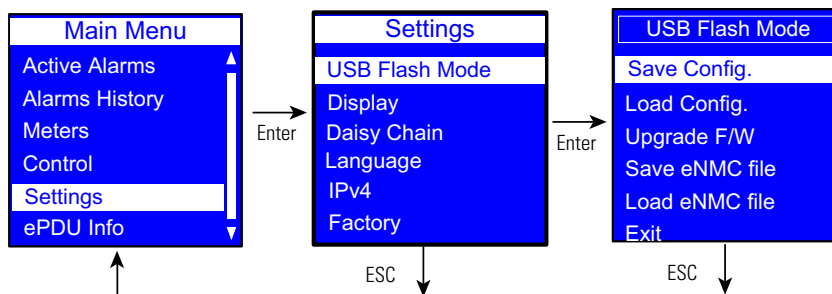

Figure 55. Example Save Config.

7. Click **OK** to continue when a successful pop-up message displays that:
 - The data from the eNMC module are saved in the ConfigurationData.xml file is saved to the USB flash drive.
 - The data from the eNMC module are saved in the ConfigurationPdu.xml file is saved to the USB flash drive.

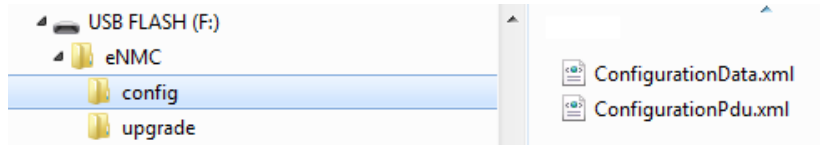

Figure 56. Example USB Flash Drive Root

8. Remove USB flash disk and select **Exit**.

Load User Configuration Data Files from the USB

This option loads the ConfigurationData.xml and ConfigurationPdu.xml files into the eNMC module from the USB device. The new parameters in these files will be applied when the eNMC module exits USB Flash Mode.

When this option is selected, the eNMC module will first attempt to load the eNMC/config/ConfigurationData.xml file from the USB device. Next, the eNMC module will attempt to load the eNMC/config/ConfigurationPdu.xml file from the USB device.

1. Verify that the USB Flash Drive contains the ConfigurationPdu.xml file and ConfigurationData.xml files in eNMC/config directory of USB flash drive (see Figure 57).

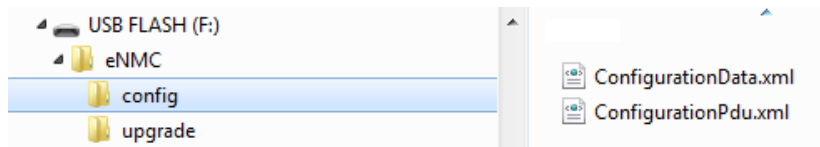

Figure 57. Verify Files at USB Flash Drive Root



NOTE 1 The eNMC/upgrade directory contains only these two files.

NOTE 2 The ConfigurationPdu.xml file is compatible with the ePDU part number.

2. Make sure eNMC module is powered ON.
3. Insert a USB flash disk.
4. When the pop-up confirms that the USB is detected, click **OK** then press **Enter** to go to the Main Menu. (If not confirmed within 10 sec, the USB flash disk is ignored by eNMC module.)
5. Select USB Flash Mode from the Settings menu. The module restarts.
6. Select Load Config then click **OK** to start loading the ConfigurationData.xml file into the eNMC module.
7. When the file is successfully loaded, click **OK** in response to the confirmation message.
8. Click OK to start loading the ConfigurationPdu.xml file into the eNMC module.
9. When the file is successfully loaded, click **OK** in response to the confirmation message.
10. Remove the USB flash drive and select **Exit** from the USB Flash Mode menu.

Save the eNMC Hardware Configuration File to the USB

To save the eNMC module HW configuration file:

1. Make sure eNMC module is powered ON.
2. Insert a USB flash disk.
3. When the pop-up confirms that the file is saved, click **OK** and press **Enter** to return to the Main Menu. (If not confirmed within 10 sec, the USB flash disk is ignored by eNMC module.)
4. From the Settings menu, select USB Flash Mode. The module restarts.
5. Select Save eNMC file. When the file is saved, click **OK** to confirm.
6. Remove USB flash disk and select **Exit**.
7. After the file is saved from the eNMC module in the eNMC/config/hw path, verify the USB flash disk contains the file in the eNMC/config/hw directory located at root of USB flash disk (see Figure 58).

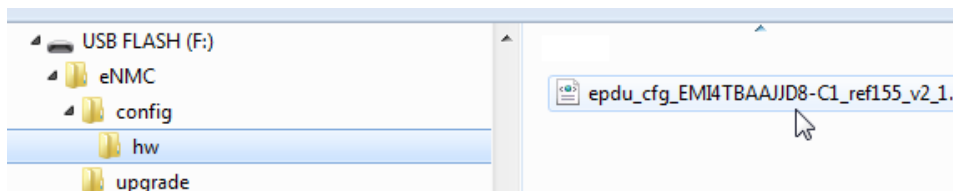

Figure 58. Verify HW File at USB Flash Drive Root

Load the eNMC Hardware Configuration File from the USB

To load the eNMC module hardware configuration file to the eNMC module from the USB Flash Drive:

1. Verify the USB flash disk contains eNMC/config/hw directory located at root of USB flash disk (see Figure 58).
2. Make sure eNMC module is powered ON.
3. Insert a USB flash disk.
4. When the pop-up confirms that the USB is detected, click **OK** then press **Enter** to return to the Main Menu. (If not confirmed within 10 sec, the USB flash disk is ignored by eNMC module.)
5. From the Settings menu, select USB Flash Mode. The module restarts. (If there is no action within one minute, the eNMC module exits the USB Flash mode. Unplug and replug the USB flash disk to access this menu again.)
6. Select Load eNMC file, then click **OK** to start loading the eNMC file.
7. When the file is successfully loaded, click **OK** in response to the confirmation message.
8. Remove the USB flash drive and select **Exit**.



NOTE 1 The eNMC/upgrade/hw directory contains only one file named epdu_cfg*.xml.

NOTE 2 epdu_cfg*.xml file shall be compatible with ePDU PN.

Upgrade the eNMC Module Firmware

To upgrade the eNMC module firmware:

1. Connect a USB flash disk to your computer and put the Image*.bin file on the flash disk in the eNMC/upgrade/ location.(see Figure 59).

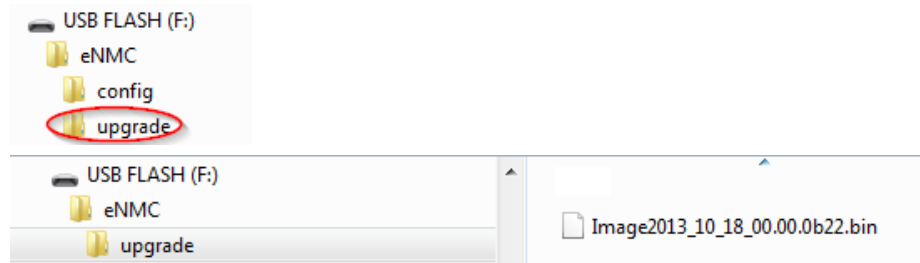

Figure 59. Root of Flash Disk

2. Make sure eNMC module is powered ON.
3. Insert the flash drive in the USB port of the eNMC front panel.
4. When the pop-up confirms that the USB is detected, click **OK** then press **Enter** to return to the Main Menu. (If not confirmed within 10 sec, the USB flash disk is ignored by eNMC module.)
5. Select USB Flash Mode. Click **Yes** to confirm you want to enter the USB Flash mode. (If there is no action within one minute, the eNMC module exits the USB Flash mode. Unplug and replug the USB flash disk to access this menu again.) The module restarts.
6. Select Upgrade FW and click **OK** to confirm the upgrade. The eNMC module gets the file from the USB flash disk.
7. A few seconds after 100% is reached, the eNMC module restarts and then enters in Boot upgrade mode to continue upgrade. The upgrade is finished when eNMC module is restarted. This can take several minutes (see Figure 60).

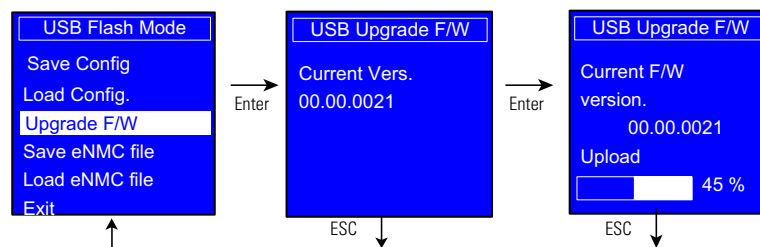

Figure 60. Example Upgrade

Exit

Select **Exit** to leave USB Flash Mode.

Display Submenu

The Display submenu allows you to customize settings for LCD contrast and orientation (see Figure 61).

On the Settings menu, scroll up or down to highlight **DISPLAY**. Press **ENTER** to display the screens to set the values for the submenu. After you select the values, press **ENTER** to set the values as displayed on the screen. Press **ESC** to return to the previous menu.

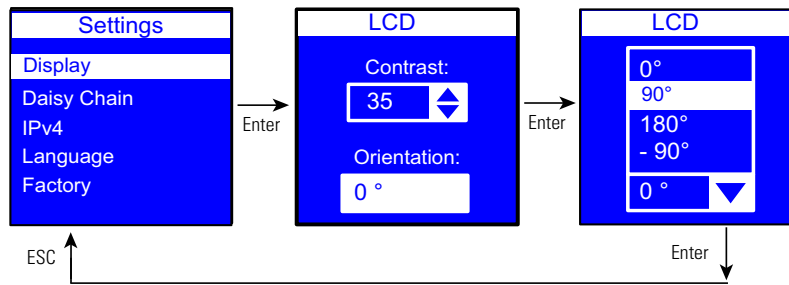

Figure 61. Example Display Submenu Displays

Daisy Chain Submenu

The Daisy Chain submenu allows you to configure two to four ePDUs to be monitored from a single Ethernet connection on the Host ePDU. Use the Daisy Chain submenu options (Settings and Discovery) to configure the ePDUs.

NOTE 1 To configure and monitor the ePDUs, they must be connected together through the Daisy Chain connector on the front panel using an Ethernet cable.



NOTE 2 The Host ePDU must be connected to the network. There can only be one Host.

NOTE 3 All daisy-chained ePDUs should have the same Configuration number. Daisy-chaining G3 ePDUs of different configuration numbers may lead to unpredictable results.

Use the Settings option for the first two configuration steps:

1. From the ePDU (or ePDUs) designated as a Device ePDU, access the Daisy Chain Settings option and set the Device values.
2. From the ePDU designated as the Host ePDU, access the Daisy Chain Settings option and set the Host values.

Use the Discovery option for the final configuration step:

3. From the Host ePDU, access the Daisy Chain Discovery option to start communication between the Host and the Device ePDU (or ePDUs).

Daisy Chain Settings Options

The Daisy Chain Settings option allows you to specify the ePDU that will be the Host (the ePDU that has the network connection) and the ePDU (or ePDUs) that will be a Device.

From the **Device** ePDU (or ePDUs), set the values as follows (see Figure 62):

1. On the Settings menu, scroll up or down to highlight **Daisy Chain** and press **ENTER**.
2. Scroll up or down to highlight **Daisy Chain** and press **ENTER**.
3. Select **1 (Device)**, **2 (Device)**, or **3 (Device)**, from the Id: selection drop-list. Press **ENTER**.
4. Select **End** or **Middle** from the Place: selection drop-list. Press **ENTER**.

NOTE 1 Select **End** when only two ePDUs are daisy-chained together.



NOTE 2 Select **Middle** when the ePDU (or ePDUs) are connected between a host and another ePDU.

NOTE 3 Select **End** when assigning the last device in the chain when daisy-chaining three or four ePDUs.

5. Press **ESC** to return to the previous menu.

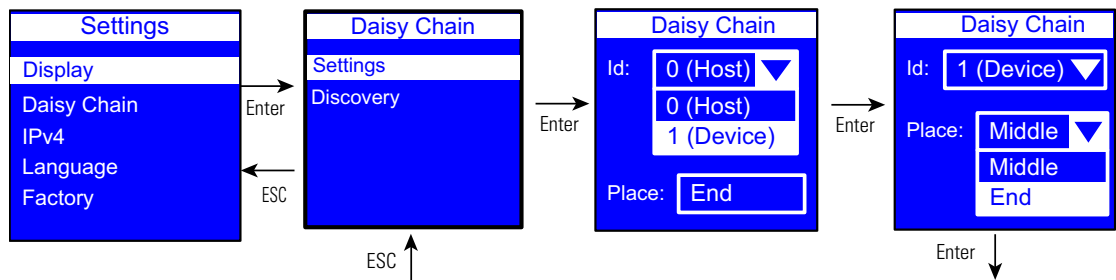

Figure 62. Example Daisy Chain Device ePDU Setup

From the **Host** ePDU, set the values as follows (see Figure 63):

1. On the Settings menu, scroll up or down to highlight **Daisy Chain** and press **ENTER**.
2. Scroll up or down to highlight **Settings** and press **ENTER**.
3. Select **0 (Host)** from the Id: selection drop-list. Press **ENTER**.
4. Select **End** from the Place: selection drop-list. Press **ENTER**.
5. Press **ESC** to return to the previous menu.

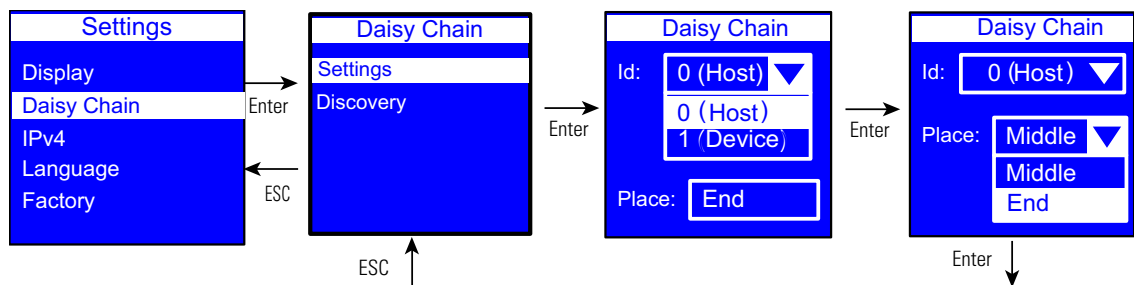

Figure 63. Example Daisy Chain Host ePDU Setup

Daisy Chain Discovery Options

The Discovery option starts communication between the Host ePDU and the Device ePDU. This is only available for the Host ePDU. The display you see varies depending on whether the ePDU is communicating properly or not communicating (see Figure 64 and Figure 65).

From the Host ePDU, perform a Discovery as follows:

1. On the Settings menu, scroll up or down to highlight **Daisy Chain** and press **ENTER**.
2. Scroll up or down to highlight **Discovery**.
3. Press **ENTER** to perform the discovery.
 - When the discovery completes successfully, the Media Access Control (MAC) address of the Device ePDU displays (see Figure 46). Go to Step 4.
 - If there is no connection, the **No device chained** error message displays (see Figure 47). Go to the Daisy Chain Settings option screens and reset the values to correctly identify the Host. Once corrected, then select the Discovery option again.
 - If the Host and Device ePDUs have been incorrectly identified, a **Host Conflict** error message displays. Go to the Daisy Chain Settings option screens and reset the values to correctly identify the Host and Device. Once corrected, select the Discovery option again.
4. Press **ENTER** to validate the Discovery.
5. Press **ESC** to return to the previous menu.

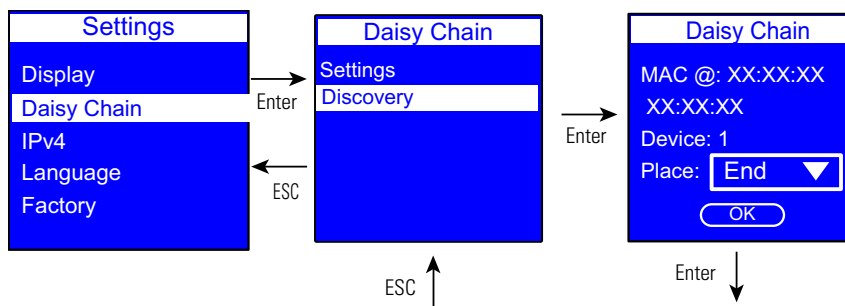

Figure 64. Example Daisy Chain ePDU Discovery (Communicating)

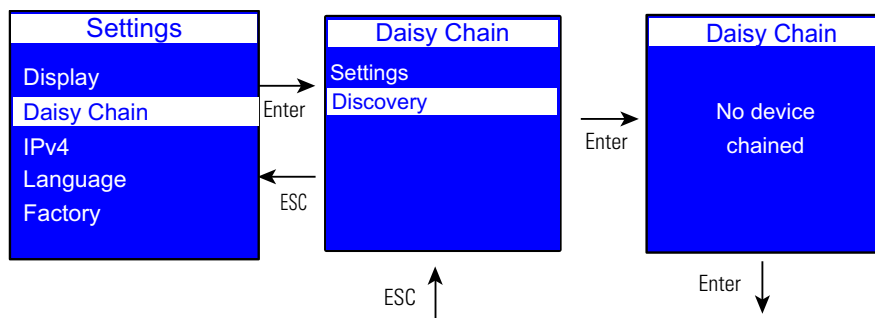

Figure 65. Example Daisy Chain ePDU Discovery (Not Communicating)

IPv4 Submenu

The IPv4 submenu allows you to set options for:

- DHCP
- IP address
- Subnet Mask
- Gateway

Figure 66 shows the IP Address displays.

On the Settings menu, scroll up or down to highlight IPv4. Press **ENTER** to display the options screen. Scroll up or down to highlight the selected option from the menu. Press **ENTER** to display the screens to set the values for the selected option. After you select the values, press **ENTER** to set the values as displayed on the screen. Press **ESC** to return to the previous menu.

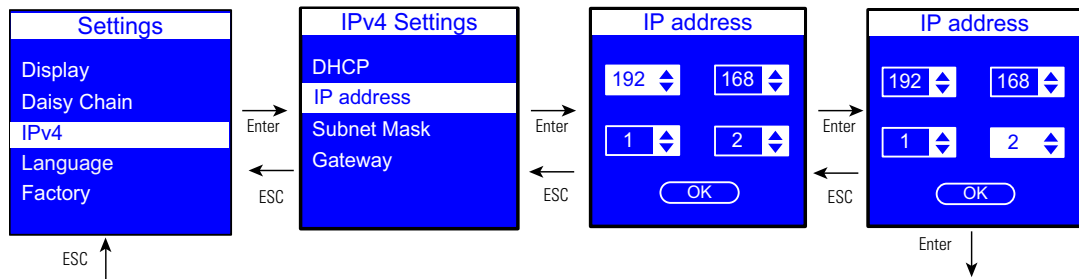

Figure 66. Example IPv4 Submenu Displays

Language Submenu

On the Settings menu, scroll up or down to highlight Language. Press **ENTER**. Scroll up or down to highlight the selected language option from the menu. Press **ENTER** to set the selected language. Press **ESC** to return to the previous menu (see Figure 67).

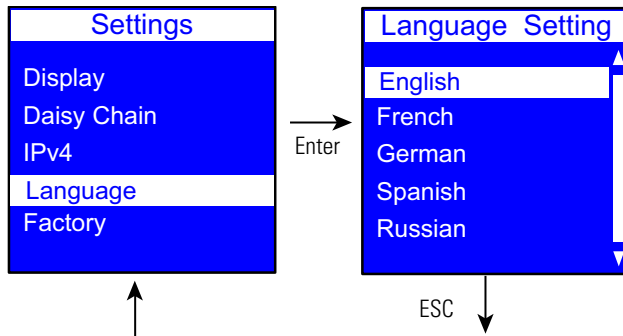

Figure 67. Example Language Setting

Factory Submenu

The Factory submenu allows you to reset the ePDU to the factory settings (see Figure 68).

On the Settings menu, scroll down to highlight Factory. Press **ENTER** to display the screens to set and confirm the return to factory settings. After you make the selections, press **ENTER** to set the values as displayed on the screen. Press **ESC** to return to the previous menu.

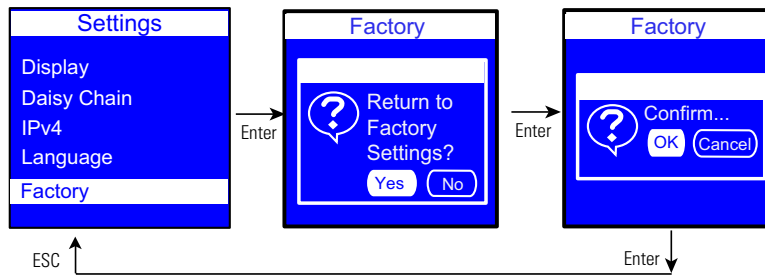

Figure 68. Example Factory Submenu Displays

ePDU Info Menu

The ePDU Info menu provides identification information for this ePDU. The identification information includes the ePDU model type and part number, serial number, ePDU Network Management and Control (eNMC) module firmware version number, IP address, and ePDU Network Management and Control (eNMC) module MAC (Media Access Control) address. These are information-only screens (see Figure 69).

On the Main Menu, scroll up or down to highlight ePDU Info. Press **ENTER** to navigate to each screen. Scroll up or down on the screen if needed to view the ePDU information displays. Press **ESC** to return to the previous menu.

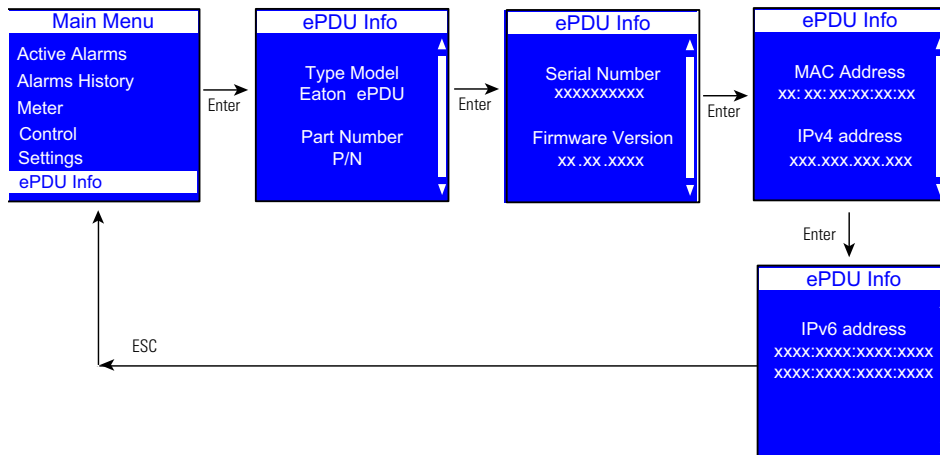

Figure 69. Example ePDU Info Display

Chapter 7 Serial Interface Operation

This section describes the command line interface (CLI) commands used to remotely configure and monitor the Eaton Enclosure Power Distribution Unit (ePDU) G3 through the serial interface connection or network connection between the and a laptop or workstation.

Access to a CLI is provided through a terminal emulation program, such as HyperTerminal, Telnet, or SSH. A maximum of five concurrent sessions (Telnet or RS-232 port) are allowed.

Supported Commands

The ePDU CLI command set for managing and monitoring the ePDU includes the following commands:

- ?
- info
- quit
- get
- set
- pdu

NOTE Observe the following:



- Command variables are represented in command input syntax surrounded by angle braces (< >).
- Optional parameters are represented in command input syntax surrounded by straight brackets ([]).
- For data of type array, the 'x' character as index of array in command input syntax means all indexes.
- Commands are case sensitive, but object names are not case sensitive.



NOTE You must be logged into the ePDU before commands can be sent.

? command

Use this command to list all available ePDU CLI commands or receive detailed help on specified commands

Usage

```
pdu#0>?
pdu#0><command> ?
```

where:

<command> = infor, get, set, pdu

List all available ePDU CLI commands

```
pdu#0>?
```

Example

```
pdu#0>?
Usage: ? info get set pdu quit
pdu#0>
```

List detailed help on a specific ePDU CLI command

```
pdu#0><command> ?
```

Example 1

```
pdu#0>set ?
Usage: change the device data defined by its' name followed by the new value set
[name] [value]
pdu#0>
```

Example 2

```
pdu#0>pdu ?
Usage: select the strapping pdu unit to focus on pdu [number]
PDU#0
```

info command

Use this command to display the device data defined by its name information (info [name]).

```
pdu#0>info ?
      info [System]
      info [Network]
      info [User]
      info [Access]
      info [Time]
      info [eMail]
      info [SNMP]
      info [NetworkManagement]
      info [EnergyWise]
      info [DaisyChain]
      info [UserDefinedGroup]
      info [PowerSchedule]
      info [Summary]
      info [Input1]
      info [Input2] NOTE 1
      info [Gang]
      info [Outlet]
      info [Environment]
```

```
pdu#0>
```

NOTE 1: On Dual Input ePDU only.

Usage

```
pdu#0>info <object>
```

where:

<object> = name of a simple object, an object of type array or a family of objects.

Example 1

```
pdu#0>info System.*
```

Name	Data	Default	RW/RO
System.Contact	String:31	""	RW
System.Location	String:31	""	RW
System.Network.HostName	String:31	"epduF0"	RW
PDU.PowerSummary.iName	String:31	"ePDU"	RW
System.Ethernet.iVersion	String:10		RO
System.FirmwareUpgradeMode	Boolean	0	RW
System.FirmwareUpgrade	Boolean	1	RW
System.Restart	Boolean	0	RW
System.FactoryReset	Boolean	0	RW
System.LogReset	Boolean	0	RW
System.KeepIP	Boolean	0	RW

Example 2

```
pdu#0>info System.Network.DHCP
```

Name	Unit	RO/RW	Type
----	----	-----	-----
System.Network.DHCP		RW	0: Disabled 1: Enabled

quit command

Use this command to log out and exit the serial or network interface for the ePDU.

Usage

```
pdu#0>quit
```

Log out of the CLI

```
pdu#0>quit
```

Example with serial interface

```
pdu#0>quit  
Session closed
```

Example with network interface

```
pdu#0>quit  
Connection to host lost.
```

get command

Use this command to view the value an object or a family of objects that belong to the HID database or a card parameter.

Usage

```
pdu#0>get <object>
```

where:

<object> = a simple object, an object of type array or a family of objects.

Get a single value

```
pdu#0>get <path>.<name>
```

Example

```
pdu#0>get System.Network.DHCP
1
pdu#0>
```

Get the size of an array

```
pdu#0>get <path>.Count
```

Example

```
pdu#0>get System.NetworkManagementSystem.Count
8
pdu#0>
```

Get a single value of an array

```
pdu#0>get <path[i]>.<name>
```

where:

[i] = the index in the array, from 1 to *n*. The value of *n* depends of the HID object and is obtained with a **get** command

Example

```
pdu#0>get System.NetworkManagementSystem[1].TrapCommunity
public
pdu#0>
```

Get all values of an array

```
pdu#0>get <path[x]>.<name>
```



NOTE Values are separated by the pipe character (|).

Example

```
pdu#0>get System.User[x].SecurityRight
0|0|0|0|0|0|0|0
pdu#0>
```

Get all values of a family

```
pdu#0>get <short path>.*
```

where

<short path> = incomplete path name. A node must be complete.

Example 1**Example 2**

```
pdu#0>get System.*
System.NetworkManagementSystem.Count
8
System.NetworkManagementSystem[x].HostName
../..
pdu#0>
```

Get Daisy-chained ePDU to Supervise or Retrieve Communication Status

```
pdu#0> pdu [x]
pdu#0>get <short path>.*
```

where

[x] = value 0 to 3 to indicate Host (0) or device (1, 2, or 3) to supervise; enter key to accept prompt ePDU ID

<short path> = incomplete path name. A node must be complete.

Example 1

```
pdu#0>get System.DaisyChain.*
System.DaisyChain.DeviceId
0
System.DaisyChain.Position
1
System.DaisyChain.Status
1
System.DaisyChain.Count
1
pdu#0>
```

NOTE 1 The communication status is returned for the selected Device or Host by `System.DaisyChain.Status`. The Status value is:

- 0: No Communication
- 1: Communication OK
- 2: Communication failed
- 3: Host conflict
- 4: Device conflict



NOTE 2 The Count command value is the number of ePDUs connected in the daisy-chain configuration.

set command

Use this command to change the value of an object that belongs to the HID database or a card parameter.



NOTE Some data cannot be modified without appropriate user access rights.

Usage

```
pdu#0>set <object> <value>
```

where:

<object> = a simple object or an object of type array.

<value> = a value or a list of values separate with the pipe character (|). For a value of type string, the space character ' ' is taken into account.

Set a single value

```
pdu#0>set <path>.<name> <value>
```

Example 1

```
pdu#0>set System.Network.DHCP 1
1
pdu#0>
```

Example 2

```
pdu#0>set System.Display.LcdRotation 1
1
pdu#0>
```

where:

<0> = Rotation 0 Degrees (0U).

<1> = Rotation 90 Degrees (IL).

<2> = Rotation 180 Degrees (0U).

<3> = Rotation 270 Degrees (IL).

Set value of an array

```
pdu#0>set <path[i]>.<name> <value>
```

where:

[i] = the index in the array, from 1 to *n*. The value of *n* depends of the HID object and is obtained with a **get** command

Example

```
pdu#0>set System.Network.SNMP.V3.User[1].Name User 1
User 1
pdu#0>
```

set all values of array

```
pdu#0>set <path[x]>.<name> <value 1>[|<value 2>]../..[|<value n>]
```



NOTE Values are separated by the pipe character (|).

Example

```
pdu#0>set System.Network.SNMP.V3.User[x].Name User 1|User 2|User 3|User 4
User 1|User 2|User 3|User 4
pdu#0>
```

Set Daisy Chain**Device ID and Position**

```
pdu#0>set System.DaisyChain.DeviceID [x]
```

where:

[x] = value from 1 to 3 as a unique identifier for each device

(Zero is reserved for the Host.)

```
pdu#0>set System.DaisyChain.Position [x]
```

where:

[x] = 0 for a device ePDU connected between two other ePDUs; 1 for a device ePDU connected to just one ePDU

Example

```
pdu#0>set System.DaisyChain.DeviceID
1
pdu#0>
```

```
pdu#0>set System.DaisyChain.Postion 1
1
pdu#0>
```

Host ID and Position

```
pdu#0>set System.DaisyChain.DeviceID [x]
```

where:

[x] = enter 0 as a unique identifier for the host only

```
pdu#0>set System.DaisyChain.Position [x]
```

where:

[x] = 0 if the host ePDU is connected between two other ePDUs; 1 if the host ePDU is connected to just one ePDU

Example

```
pdu#0>set System.DaisyChain.DeviceID 0  
0  
pdu#0>
```

```
pdu#0>set System.DaisyChain.Postion 1  
1  
pdu#0>
```

See to review an example to get the communication status.

pdu command

Use this command to reset a daisy-chained ePDU as the Host or Device.

Usage

```
pdu#0>pdu <value>
```

where:

<value> = 0 for the host; 1 for the device

Example

```
pdu#0>pdu 1  
pdu#1>
```

XML Object Tables

This section includes tables that define ePDU CLI objects (Table 8) and System CLI Objects (Table 9 on page 84).

Table 8. ePDU CLI Objects

XML Object Name	Type	Description	Unit	Access
Environment.ChangedStatus.CommunicationLost	Timestamp	Timestamp of last changing state of the alarm that has the same name in the collection PresentStatus.	s	RO
Environment.ChangedStatus.OverHumidity	Timestamp	Timestamp of last changing state of the alarm that has the same name in the collection PresentStatus.	s	RO
Environment.ChangedStatus.OverTemperature	Timestamp	Timestamp of last changing state of the alarm that has the same name in the collection PresentStatus.	s	RO
Environment.Humidity	Measure	Measured Humidity on environmental monitoring probe. 0 when no probe is connected or when the probe does not have a humidity sensor.	d%	RO
Environment.Input[1].ChangedStatus.Alarm	Timestamp	Timestamp of last changing state of the alarm that has the same name in the collection PresentStatus.	s	RO
Environment.Input[1].iName	String[31]	Contact 1 friendly name	-	RW
Environment.Input[1].PresentStatus.Alarm	AlarmL1	Dry Contact alarm. Set according to the dry contact State and the parameter State[0] or [1].Level 0: Alarm not active 1: Alarm active Ex: State=0 AND State[0].Level=3 then Alarm=1	-	RO
Environment.Input[1].PresentStatus.State	Measure	Dry Contact state 0: Open 1: Close	-	RO
Environment.Input[1].State[0].Level	Parameter	Dry contact Config 1: Open makes just informational 0 into State. 2: Open makes Warning trap 3: Open makes Alarm trap	-	RW
Environment.Input[1].State[1].Level	Parameter	Dry contact Config 1: Close makes just informational 0 into State. 2: Close makes Warning trap 3: Close makes Alarm trap	-	RW
Environment.Input[2].ChangedStatus.Alarm	Timestamp	Timestamp of last changing state of the alarm that has the same name in the collection PresentStatus.	s	RO
Environment.Input[2].iName	String[31]	Contact 2 friendly name	-	RW
Environment.Input[2].PresentStatus.Alarm	AlarmL1	Dry Contact alarm. Set according to the dry contact State and the parameter State[0] or [1].Level 0: Alarm not active 1: Alarm active Ex: State=0 AND State[0].Level=3 then Alarm=1	-	RO
Environment.Input[2].PresentStatus.State	Measure	Dry Contact state 0: Open 1: Close	-	RO

Table 8. ePDU CLI Objects (Continued)

XML Object Name	Type	Description	Unit	Access
Environment.Input[2].State[0].Level	Parameter	Dry contact Config 1: Open makes just informational 0 into State. 2: Open makes Warning trap. 3: Open makes Alarm trap.	-	RW
Environment.Input[2].State[1].Level	Parameter	Dry contact Config 1: Close makes just informational 0 into State. 2: Close makes Warning trap. 3: Close makes Alarm trap.	-	RW
Environment.OverHumidity[1].Threshold	Parameter		d%	RW
Environment.OverHumidity[2].Threshold	Parameter		d%	RW
Environment.OverHumidity[3].Threshold	Parameter		d%	RW
Environment.OverHumidity[4].Threshold	Parameter		d%	RW
Environment.OverTemperature[1].Threshold	Parameter		d°K	RW
Environment.OverTemperature[2].Threshold	Parameter		d°K	RW
Environment.OverTemperature[3].Threshold	Parameter		d°K	RW
Environment.OverTemperature[4].Threshold	Parameter		d°K	RW
Environment.PresentStatus.CommunicationLost	AlarmL1	0: OK 1: Communication failure with the sensor probe or probe not present.	-	RO
Environment.PresentStatus.OverHumidity	AlarmL1	0: No threshold triggered 1: Warning low threshold triggered 2: Critical low threshold triggered 3: Warning high threshold triggered 4: Critical high threshold triggered	-	RO
Environment.PresentStatus.OverTemperature	AlarmL1	0: No threshold triggered 1: Warning low threshold triggered 2: Critical low threshold triggered 3: Warning high threshold triggered 4: Critical high threshold triggered	-	RO
Environment.PresentStatus.Present	Measure	0: Sensor probe never connected since F/W starts. 1: Sensor probe connected at least 1 time since F/W starts.	-	RO
Environment.Temperature	Measure	Measured Temperature on environmental monitoring probe. It is 0 when no probe is connected.	d°K	RO
PDU.DaisyChain[x].ChangedStatus.CommunicationLost	Timestamp	Communication with daisy chained device has failed, datation of the alarm.	s	RO
PDU.DaisyChain[x].iName	String[15]	Daisy chain friendly name	-	RO
PDU.DaisyChain[x].PresentStatus.CommunicationLost	AlarmL1	Communication with daisy chained device has failed.	-	RO
PDU.Gang.Count	Constant	Number of factory groups in the PDU.	-	RO
PDU.Gang[x].ActivePower	Measure	Active Power provided by the breaker/section. For a double pole breaker, the apparent power for the two poles is combined.	dW	RO

Table 8. ePDU CLI Objects (Continued)

XML Object Name	Type	Description	Unit	Access
PDU.Gang[x].ApparentPower	Measure	Apparent Power provided by the breaker/section. For a double pole breaker, the apparent power for the two poles is combined.	dVA	RO
PDU.Gang[x].ChangedStatus.OverCurrent	Timestamp		s	RO
PDU.Gang[x].ChangedStatus.OverVoltage	Timestamp		s	RO
PDU.Gang[x].ChangedStatus.SwitchOnOff	Time stamp		s	RO
PDU.Gang[x].ConfigCurrent	Constant	Nominal Amps: 10A, 16A, 20A, .. This is useful for both breaker and outlet section.	mA	RO
PDU.Gang[x].Current	Measure	Current provided by the breaker/section. For a double pole breaker, it is calculated as the max of the two poles current.	mA	RO
PDU.Gang[x].EWEntity.Importance	Parameter	Energy Wise Importance	-	RW
PDU.Gang[x].EWEntity.Keyword	String[31]	Energy Wise Keyword	-	RW
PDU.Gang[x].EWEntity.Level	Parameter	Energy Wise Level	-	RW
PDU.Gang[x].EWEntity.Role	String[31]	Energy Wise Role	-	RW
PDU.Gang[x].GangID	Constant	Breaker ID = x(1,2,..)	-	RO
PDU.Gang[x].iGang	String[15]	Breaker/section silk-screened name. Example: 'A' or 'B'	-	RO
PDU.Gang[x].iName	String[31]	Breaker/section friendly name.	-	RW
PDU.Gang[x].InputID	Constant	Identify which Input is powering the group. This is useful when the PDI is dual Input.	-	RO
PDU.Gang[x].OverCurrent[1].Threshold	Parameter		mA	RW
PDU.Gang[x].OverCurrent[3].Threshold	Parameter		mA	RW
PDU.Gang[x].OverCurrent[4].Threshold	Parameter		mA	RW
PDU.Gang[x].OverVoltage[1].Threshold	Parameter	Threshold	cV	RW
PDU.Gang[x].OverVoltage[2].Threshold	Parameter	Threshold	cV	RW
PDU.Gang[x].OverVoltage[3].Threshold	Parameter	Threshold	cV	RW
PDU.Gang[x].OverVoltage[4].Threshold	Parameter	Threshold	cV	RW
PDU.Gang[x].PeakFactor	Measure	Crest factor of the current provided by the breaker/section. A double pole breaker is calculated as the max of the two poles crest factor.	m%	RO
PDU.Gang[x].PercentLoad	Measure	Percent load consumed by the breaker/section. It is the ratio: current consumed / the nominal current.	%	RO
PDU.Gang[x].PhaseID	Constant	Phase number that is connected to the breaker/section: 1, 2, or 3. A double pole breaker is ij. Ex: 12 if the 2 phases are L1 and L2.	-	RO
PDU.Gang[x].Pole[1].ActivePower	HideMeasure	Active Power provided by the pole.	dW	RO
PDU.Gang[x].Pole[1].ApparentPower	HideMeasure	Apparent Power provided by the pole.	dVA	RO
PDU.Gang[x].Pole[1].Current	HideMeasure	Current provided by the pole.	mA	RO
PDU.Gang[x].Pole[1].PeakFactor	HideMeasure	Crest factor of the current provided by the pole.	m%	RO
PDU.Gang[x].Pole[1].PhaseID	Constant	Phase number that is connected to the pole: 1, 2, or 3.	-	RO
PDU.Gang[x].Pole[1].PowerFactor	HideMeasure	Ratio of active power / apparent power provided by the pole of the breaker or outlet section.	m%	RO

Table 8. ePDU CLI Objects (Continued)

XML Object Name	Type	Description	Unit	Access
PDU.Gang[x].Pole[1].ReactivePower	HideMeasure	Reactive Power provided by the pole.	dVA R	RO
PDU.Gang[x].Pole[1].Statistic[4].Energy	HideMeasure	Energy counter since last reset. As it is reset to 0, the related timestamp is updated with the current RTC value.	Wh	RO
PDU.Gang[x].Pole[1].Statistic[5].Energy	HideMeasure	Energy counter since last reset. When it is reset to 0 then at the same time the related timestamp is updated with the current RTC value.	Wh	RO
PDU.Gang[x].Pole[1].Voltage	HideMeasure	Voltage Measured on the pole.	cV	RO
PDU.Gang[x].Pole[2].ActivePower	HideMeasure	Active Power provided by the pole.	dW	RO
PDU.Gang[x].Pole[2].ApparentPower	HideMeasure	Apparent Power provided by the pole.	dVA	RO
PDU.Gang[x].Pole[2].Current	HideMeasure	Current Power provided by the pole.	mA	RO
PDU.Gang[x].Pole[2].PeakFactor	HideMeasure	Crest factor of the current provided by the pole.	m%	RO
PDU.Gang[x].Pole[2].PhaseID	Constant	Phase number that is connected to the pole: 1, 2, or 3.	-	RO
PDU.Gang[x].Pole[2].PowerFactor	HideMeasure	Ratio of active power / apparent power provided by the pole of the breaker or outlet section.	m%	RO
PDU.Gang[x].Pole[2].ReactivePower	HideMeasure	Reactive Power provided by the pole.	dVA R	RO
PDU.Gang[x].Pole[2].Statistic[4].Energy	HideMeasure	Energy counter since last reset. As it is reset to 0, the related timestamp is updated with the current RTC value.	Wh	RO
PDU.Gang[x].Pole[2].Voltage	HideMeasure	Voltage Measured on the pole.	cV	RO
PDU.Gang[x].PowerFactor	Measure	Ratio of active power / apparent power provided by the breaker or outlet section.	m%	RO
PDU.Gang[x].PresentStatus.OverCurrent	AlarmL1	0: No threshold triggered 1: Warning low threshold triggered 2: Critical low threshold triggered 3: Warning high threshold triggered 4: Critical high threshold triggered	-	RO
PDU.Gang[x].PresentStatus.OverVoltage	AlarmL1	0: No threshold triggered 1: Warning low threshold triggered 2: Critical low threshold triggered 3: Warning high threshold triggered 4: Critical high threshold triggered	-	RO
PDU.Gang[x].PresentStatus.SwitchOnOff	AlarmL1		-	RO
PDU.Gang[x].PresentStatus.Tripped	AlarmL1	0 : Breaker closed 1 : Breaker tripped (or open)	-	RO
PDU.Gang[x].ReactivePower	Measure	Reactive Power provided by the breaker/section. For a double pole breaker, the reactive power for the two poles is combined.	dVA R	RO
PDU.Gang[x].Statistic[3].Current	Measure	Current peak consumption since last reset. As it is reset to 0, the related timestamp is updated with the current RTC value. When a value higher than the stored value is detected, the stored value is overwritten.	mA	RO

Table 8. ePDU CLI Objects (Continued)

XML Object Name	Type	Description	Unit	Access
PDU.Gang[x].Statistic[3].ModuleReset	Command	Command to Reset the stat. This command puts 0 in the max and saves the current value of Timer.	-	RW
PDU.Gang[x].Statistic[3].Reset.Time	Measure	Timestamp saved when the stat reset is performed.	s	RO
PDU.Gang[x].Statistic[3].Time	Measure	Timestamp saved at the moment where the current peak consumption is reset.	s	RO
PDU.Gang[x].Statistic[4].Energy	Measure	Energy counter since PDU startup. For a double pole breaker, it is calculated as the accumulation of the two poles energy counter.	Wh	RO
PDU.Gang[x].Statistic[4].ModuleReset	Command	Command to Reset the stat, This command does not put 0 in the counter, but saves the current value of Energy timer into the data, Reset.Energy.	-	RW
PDU.Gang[x].Statistic[4].Reset.Energy	Measure	Energy saved when the user resets the stat.	Wh	RO
PDU.Gang[x].Statistic[4].Reset.Time	Measure	Timestamp saved when the user resets the stat.	s	RO
PDU.Gang[x].Statistic[5].Energy	Measure	Energy counter since ePDU start. If it's a double pole breaker, it is calculated as the cumul of the two poles energy counter.	Wh	RO
PDU.Gang[x].Statistic[5].ModuleReset	Command	Command to Reset the stat, this command does not put 0 in the counter but saves the current value of Energy timer into the data ...Reset.Energy.	-	RW
PDU.Gang[x].Statistic[5].Reset.Energy	Measure	Energy saved at the instant the user resets the stat.	Wh	RO
PDU.Gang[x].Statistic[5].Reset.Time	Measure	Timestamp saved at the instant the user resets the stat.	s	RO
PDU.Gang[x].Type	Constant	Type of gang: 1: Section of outlets (with 1 measurement) 2: Section of outlets (with 2 measurement, 1st method of wiring CT, current is max of 2 pole measures) 3: Section of outlets (with 2 measurement, 2nd method of wiring CT, current is sum of 2	-	RO
PDU.Gang[x].Voltage	Measure	Voltage Measured on the breaker/section. For a double pole breaker, it is the Li to Lj voltage.	cV	RO
PDU.Input[1].ActivePower	Measure	Active Power Measurement. It is the accumulation of 1 or 3 phase measures.	dW	RO
PDU.Input[1].ApparentPower	Measure	Apparent Power Measurement. It is the accumulation of 1 or 3 phase measures.	dVA	RO
PDU.Input[1].ChangedStatus.FrequencyOutOfRange	Timestamp		s	RO
PDU.Input[1].Frequency	Measure	Frequency Measurement.	dHz	RO
PDU.Input[1].Mode	Constant	Wiring Mode 0: Wye Measuring 1: Delta Measuring 2: Wye Current and Delta Measuring	-	RO
PDU.Input[1].Phase.Count	Constant	Number of phase managed by the Input module.	-	RO
PDU.Input[1].Phase[x].ActivePower	Measure	Active Power Measurement.	dW	RO
PDU.Input[1].Phase[x].ApparentPower	HideMeasure	Apparent Power Measurement.	dVA	RO
PDU.Input[1].Phase[x].ChangedStatus.OverCurrent	Timestamp	Timestamp of last changing state of the alarm that has the same name in the collection PresentStatus.	s	RO

Table 8. ePDU CLI Objects (Continued)

XML Object Name	Type	Description	Unit	Access
PDU.Input[1].Phase[x].ChangedStatus.OverVoltage	Timestamp	Timestamp of last changing state of the alarm that has the same name in the collection PresentStatus.	s	RO
PDU.Input[1].Phase[x].Current	Measure	Current Measurement.	mA	RO
PDU.Input[1].Phase[x].OverCurrent[1].Threshold	Parameter		mA	RW
PDU.Input[1].Phase[x].OverCurrent[3].Threshold	Parameter		mA	RW
PDU.Input[1].Phase[x].OverCurrent[4].Threshold	Parameter		mA	RW
PDU.Input[1].Phase[x].OverVoltage[1].Threshold	Parameter		cV	RW
PDU.Input[1].Phase[x].OverVoltage[2].Threshold	Parameter		cV	RW
PDU.Input[1].Phase[x].OverVoltage[3].Threshold	Parameter		cV	RW
PDU.Input[1].Phase[x].OverVoltage[4].Threshold	Parameter		cV	RW
PDU.Input[1].Phase[x].PeakFactor	Measure	Crest factor of the current provided by the phase.	m%	RO
PDU.Input[1].Phase[x].PercentLoad	Measure	Percent load consumed on the phase. It is the ratio: current consumed / the nominal current of the PDU.	%	RO
PDU.Input[1].Phase[x].PhaseID	Constant	Phase ID identifier depending of the wiring: 1: Line 1 to Neutral 2: Line 2 to Neutral 3: Line 3 to Neutral 12: Line 1 to Line 2 23: Line 2 to Line 3 31: Line 3 to Line 1	-	RO
PDU.Input[1].Phase[x].PowerFactor	HideMeasure	Ratio of active power / apparent power provided by the phase. Value 0 to 100 for Cos PHI = 0.00 to 1.00	m%	RO
PDU.Input[1].Phase[x].PresentStatus.OverCurrent	AlarmL1	0: No threshold triggered 1: Warning low threshold triggered 2: Critical low threshold triggered 3: Warning high threshold triggered 4: Critical high threshold triggered	-	RO
PDU.Input[1].Phase[x].PresentStatus.OverVoltage	AlarmL1	0: No threshold triggered 1: Warning low threshold triggered 2: Critical low threshold triggered 3: Warning high threshold triggered 4: Critical high threshold triggered	-	RO
PDU.Input[1].Phase[x].ReactivePower	HideMeasure	Reactive Power Measurement.	dVA R	RO
PDU.Input[1].Phase[x].Statistic[4].Energy	HideMeasure	Energy counter since last reset. As it is reset to 0, the related timestamp is updated with the current RTC value.	Wh	RO
PDU.Input[1].Phase[x].Statistic[4].ModuleReset	Command		-	RW
PDU.Input[1].Phase[x].Statistic[4].Reset.Energy	HideMeasure	Energy counter saved at last reset. As it is reset, the related timer updated with PDU timer since 1st restart.	Wh	RO
PDU.Input[1].Phase[x].Statistic[4].Reset.Time	HideMeasure	Timestamp saved at the moment when the related energy counter is reset.	s	RO

Table 8. ePDU CLI Objects (Continued)

XML Object Name	Type	Description	Unit	Access
PDU.Input[1].Phase[x].Statistic[5].Energy	HideMeasure	Energy counter since last reset. When it is reset to 0 then at the same time the related timestamp is updated with the current RTC value.	Wh	RO
PDU.Input[1].Phase[x].Statistic[5].ModuleReset	Command		-	RW
PDU.Input[1].Phase[x].Statistic[5].Reset.Energy	HideMeasure	Energy counter saved at last reset. When it is reset, at the same time the related timer updated with PDU timer since 1st restart.	Wh	RO
PDU.Input[1].Phase[x].Statistic[5].Reset.Time	HideMeasure	Timestamp saved at the moment where the energy counter related to is reset.	s	RO
PDU.Input[1].Phase[x].Voltage	Measure	Voltage Measurement.	cV	RO
PDU.Input[1].PowerFactor	Measure	Ratio of active power / apparent power provided by the input. Value 0 to 100 for Cos PHI = 0.00 to 1.00	m%	RO
PDU.Input[1].PresentStatus.FrequencyOutOfRange	AlarmL1	0: Frequency OK 1: Frequency is out of +/- 3Hz tolerance	-	RO
PDU.Input[1].ReactivePower	Measure	Reactive Power Measurement. It is the accumulation of 1 or 3 phase measures.	dVA R	RO
PDU.Input[1].Statistic[3].ActivePower	Measure	Power peak consumption since last reset. As it is reset to 0, the related timestamp is updated with the current RTC value. When a value higher than the stored value is detected, the stored valued is overwritten.	dW	RO
PDU.Input[1].Statistic[3].ModuleReset	Command	Command to Reset the stat. This command puts 0 in the max and saves the current value of Timer into the data ...Timer and into ...Reset.Timer.	-	RW
PDU.Input[1].Statistic[3].Reset.Time	Measure	Timestamp saved at the moment when the statistic is reset.	s	RO
PDU.Input[1].Statistic[3].Time	Measure	Timestamp saved at the moment when the statistic is reset.	s	RO
PDU.Input[1].Statistic[4].Energy	Measure	Energy counter since last reset. As it is reset to 0, the related timestamp is updated with the current RTC value. It combines the energy consumed on 1 or 3 phases.	Wh	RO
PDU.Input[1].Statistic[4].ModuleReset	Command	Command to Reset the stat. This command does not put 0 in the counter, but it saves the current value of Energy timer into the data ...Reset.Energy.	s	RW
PDU.Input[1].Statistic[4].Reset.Energy	Measure	Energy saved at the instant the user resets the stat.	Wh	RO
PDU.Input[1].Statistic[4].Reset.Time	Measure	Timestamp saved at the instant the user resets the stat.	s	RO
PDU.Input[1].Statistic[5].Energy	Measure	Energy counter since last reset. When it is reset to 0 then at the same time the related timestamp is updated with the current RTC value. It cumulates the energy consumed on 1 or 3 phases.	Wh	RO
PDU.Input[1].Statistic[5].ModuleReset	Command	Command to Reset the stat, this command does not put 0 in the counter but saves the current value of Energy timer into the data ...Reset.Energy.	s	RW

Table 8. ePDU CLI Objects (Continued)

XML Object Name	Type	Description	Unit	Access
PDU.Input[1].Statistic[5].Reset.Energy	Measure	Energy saved at the instant the user resets the stat.	Wh	RO
PDU.Input[1].Statistic[5].Reset.Time	Measure	Timestamp saved at the instant the user resets the stat.	s	RO
PDU.Input[1].Type	Constant	List types of PDU Input plugs.	-	RO
PDU.Input[2].ActivePower	Measure	Active Power Measurement. It's the cumul of 1 or 3 phase measures.	dW	RO
PDU.Input[2].ApparentPower	Measure	Apparent Power Measurement. It's the cumul of 1 or 3 phase measures.	dVA	RO
PDU.Input[2].ChangedStatus.FrequencyOutOfRange	Timestamp		s	RO
PDU.Input[2].Frequency	Measure	Frequency Measurement.	dHz	RO
PDU.Input[2].Mode	Constant	Wiring Mode 0: Wye Measuring 1: Delta Measuring 2 : Wye Current and Delta Measuring	-	RO
PDU.Input[2].Phase.Count	Constant	Number of phase managed by the Input module.	-	RO
PDU.Input[2].Phase[x].ActivePower	Measure	Active Power Measurement.	dW	RO
PDU.Input[2].Phase[x].ApparentPower	HideMeasure	Apparent Power Measurement.	dVA	RO
PDU.Input[2].Phase[x].ChangedStatus.OverCurrent	Timestamp	Timestamp of last changing state of the alarm that has the same name in the collection PresentStatus.	s	RO
PDU.Input[2].Phase[x].ChangedStatus.OverVoltage	Timestamp	Timestamp of last changing state of the alarm that has the same name in the collection PresentStatus.	s	RO
PDU.Input[2].Phase[x].Current	Measure	Current Measurement.	mA	RO
PDU.Input[2].Phase[x].OverCurrent[1].Threshold	Parameter		mA	RW
PDU.Input[2].Phase[x].OverCurrent[3].Threshold	Parameter		mA	RW
PDU.Input[2].Phase[x].OverCurrent[4].Threshold	Parameter		mA	RW
PDU.Input[2].Phase[x].OverVoltage[1].Threshold	Parameter		cV	RW
PDU.Input[2].Phase[x].OverVoltage[2].Threshold	Parameter		cV	RW
PDU.Input[2].Phase[x].OverVoltage[3].Threshold	Parameter		cV	RW
PDU.Input[2].Phase[x].OverVoltage[4].Threshold	Parameter		cV	RW
PDU.Input[2].Phase[x].PeakFactor	Measure	Crest factor of the current provided by the phase.	m%	RO
PDU.Input[2].Phase[x].PercentLoad	Measure	Percent load consumed on the phase. It is the ratio : current consumed / the nominal current of the PDU.	%	RO
PDU.Input[2].Phase[x].PhaseID	Constant	Phase ID identifier depending of the wiring : 1 : Line 1 to Neutral 2 : Line 2 to Neutral 3 : Line 3 to Neutral	-	RO
PDU.Input[2].Phase[x].PowerFactor	HideMeasure	Ratio of active power / apparent power provided by the phase. Value 0 to 100 for Cos PHI = 0.00 to 1.00	m%	RO

Table 8. ePDU CLI Objects (Continued)

XML Object Name	Type	Description	Unit	Access
PDU.Input[2].Phase[x].PresentStatus.OverCurrent	AlarmL1	0 : No threshold triggered 1 : Warning low threshold triggered 2 : Critical low threshold triggered 3 : Warning high threshold triggered 4 : Critical high threshold triggered	-	RO
PDU.Input[2].Phase[x].PresentStatus.OverVoltage	AlarmL1	0 : No threshold triggered 1 : Warning low threshold triggered 2 : Critical low threshold triggered 3 : Warning high threshold triggered 4 : Critical high threshold triggered	-	RO
PDU.Input[2].Phase[x].ReactivePower	HideMeasure	Reactive Power Measurement.	dVA R	RO
PDU.Input[2].Phase[x].Statistic[5].Energy	HideMeasure	Energy counter since ePDU start.	Wh	RO
PDU.Input[2].Phase[x].Statistic[5].ModuleReset	Command	Command to Reset the stat, this command does not put 0 in the counter but saves the current value of Energy timer into the data ...Reset.Energy.	-	RW
PDU.Input[2].Phase[x].Statistic[5].Reset.Energy	HideMeasure	Energy saved at the instant the user resets the stat.	Wh	RO
PDU.Input[2].Phase[x].Statistic[5].Reset.Time	HideMeasure	Timestamp saved at the instant the user resets the stat.	s	RO
PDU.Input[2].Phase[x].Voltage	Measure	Voltage Measurement.	cV	RO
PDU.Input[2].PowerFactor	Measure	Ratio of active power / apparent power provided by the input. Value 0 to 100 for Cos PHI = 0.00 to 1.00	m%	RO
PDU.Input[2].PresentStatus.FrequencyOutOfRange	AlarmL1	0 : Frequency OK 1 : Frequency is out of +/- 3Hz tolerance	-	RO
PDU.Input[2].ReactivePower	Measure	Reactive Power Measurement. It's the cumul of 1 or 3 phase measures.	dVA R	RO
PDU.Input[2].Statistic[3].ActivePower	Measure	Power peak consumption since last reset. When it is reset to 0 then at the same time the related timestamp is updated with the current RTC value. When it is detected higher than the value stored, so it overwrites it.	dW	RO
PDU.Input[2].Statistic[3].ModuleReset	Command	Command to Reset the stat, this command put 0 in the max and saves the current value of Timer into the data ...Timer and into ...Reset.Timer.	-	RW
PDU.Input[2].Statistic[3].Reset.Time	Measure	Timestamp saved at the moment where the statistic is reset.	s	RO
PDU.Input[2].Statistic[3].Time	Measure	Timestamp saved at the moment where the statistic is reset.	s	RO
PDU.Input[2].Statistic[5].Energy	Measure	Energy counter since ePDU start. It cumulates the energy consumed on 1 or 3 phases.	Wh	RO

Table 8. ePDU CLI Objects (Continued)

XML Object Name	Type	Description	Unit	Access
PDU.Input[2].Statistic[5].ModuleReset	Command	Command to Reset the stat, this command does not put 0 in the counter but saves the current value of Energy timer into the data ...Reset.Energy.	-	RW
PDU.Input[2].Statistic[5].Reset.Energy	Measure	Energy saved at the instant the user resets the stat.	Wh	RO
PDU.Input[2].Statistic[5].Reset.Time	Measure	Timestamp saved at the instant the user resets the stat.	s	RO
PDU.Input[2].Type	Constant	Enum all the kind of Input plug that a ePDU can have : 1=?	-	RO
PDU.MeasurementBoard.Gateway.Address	HideMeasure	Address of the teridian module to be accessed.	-	RW
PDU.MeasurementBoard.Gateway.Command	HideMeasure	Write: command to the Gateway 0: None 1: Read 2: Write Read: return the CR of last command to the Gateway: 0: Success <> 0 , Access failed for the following reasons: 1: Command Unknown. 2: Gateway not enabled. 3: Address out of range. 4: Register out of r.	-	RW
PDU.MeasurementBoard.Gateway.Count	HideMeasure	Number of 32 bits data to be read or write in consecutive READ or WRITE request. 1 to 8.	-	RW
PDU.MeasurementBoard.Gateway.Register	HideMeasure	Address of the register to be read or write.	-	RW
PDU.MeasurementBoard.Gateway.Switchable	HideMeasure	0: The gateway is disabled. 1: The gateway is enabled.	-	RW
PDU.MeasurementBoard.Gateway[x].Value	HideMeasure	1 up to 8 consecutive register values can be read or write with the gateway in one request. NOTE: Follow these steps to read registers from the board: 1. Write 1 in Command 2. Read Command, check it is 0 3. Read the data that had been read into Value	-	RW
PDU.MeasurementBoard[x].PresentStatus.CommunicationLost	Measure	Communication status with the acquisition card ICM & SM: 0: Communication OK 1: Communication failed.	-	RO
PDU.OutletSystem.Outlet.Count	Constant	Total Number of outlets	-	RO
PDU.OutletSystem.Outlet[x].ActivePower	Measure	Active Power Measurement	dW	RO
PDU.OutletSystem.Outlet[x].ApparentPower	Measure	Apparent Power Measurement	dVA	RO

Table 8. ePDU CLI Objects (Continued)

XML Object Name	Type	Description	Unit	Access
PDU.OutletSystem.Outlet[x].AutomaticRestart	Parameter	0 : not restart at device startup 1 : should sequence back ON in line with PDU.Outlet[u].RestartTimer 2 : should take the state the outlet had when power was lost. If the state was ON, should sequence back ON in line with the outlet RestartTimer.	-	RW
PDU.OutletSystem.Outlet[x].ChangedStatus.OverCurrent	Timestamp		s	RO
PDU.OutletSystem.Outlet[x].ConfigCurrent	Constant	Nominal Amps: 10A, 15A, 16A, 20A, ..	mA	RO
PDU.OutletSystem.Outlet[x].Current	Measure	Current Measurement	mA	RO
PDU.OutletSystem.Outlet[x].DelayBeforeShutdown	Command	0-n: Delayed shutoff -1: Cancel / No action When read, returns the downcount.	s	RW
PDU.OutletSystem.Outlet[x].DelayBeforeStartup	Command	0-n: Delayed restart -1: Cancel / No action When read, returns the downcount.	s	RW
PDU.OutletSystem.Outlet[x].EWEntity.Importance	Parameter	Energy Wise Importance	-	RW
PDU.OutletSystem.Outlet[x].EWEntity.Keyword	String[31]	Energy Wise Keyword	-	RW
PDU.OutletSystem.Outlet[x].EWEntity.Level	Parameter	Energy Wise Level	-	RW
PDU.OutletSystem.Outlet[x].EWEntity.Role	String[31]	Energy Wise Role	-	RW
PDU.OutletSystem.Outlet[x].GangID	Constant	Breaker/section index where the Outlet is connected. It is the x of Gang[x] collection.	-	RO
PDU.OutletSystem.Outlet[x].iName	String[31]	Outlet friendly name.	-	RW
PDU.OutletSystem.Outlet[x].OutletID	Constant	Numbering of the outlet into the breaker/section module. 1 to 56.	-	RO
PDU.OutletSystem.Outlet[x].OverCurrent[1].Threshold	Parameter	Threshold	mA	RW
PDU.OutletSystem.Outlet[x].OverCurrent[3].Threshold	Parameter	Threshold	mA	RW
PDU.OutletSystem.Outlet[x].OverCurrent[4].Threshold	Parameter	Threshold	mA	RW
PDU.OutletSystem.Outlet[x].PeakFactor	Measure	Crest factor of the current that is provided by the outlet.	m%	RO
PDU.OutletSystem.Outlet[x].PhaseID	Constant	Phase ID that powers the outlet: - 1, 2, 3 to identify a simple phase. - 12, 23, 31 to identify a composed phase.	-	RO
PDU.OutletSystem.Outlet[x].PoleID	Constant	Pole ID of the breaker/section where the Outlet is connected. Two cases are: - Section or Single pole breaker, always 0. - Double pole breaker: 0: when powered between 2 poles 1: when powered by pole 1 voltage. 2: when powered by pole 2 voltage.	-	RO
PDU.OutletSystem.Outlet[x].PowerFactor	Measure	Power factor of the current provided by the phase. Value 0 to 100 for Cos PHI = 0.00 to 1.00	m%	RO

Table 8. ePDU CLI Objects (Continued)

XML Object Name	Type	Description	Unit	Access
PDU.OutletSystem.Outlet[x].PresentStatus.OverCurrent	AlarmL1	0 : No threshold triggered 1 : Warning low threshold triggered 2 : Critical low threshold triggered 3 : Warning high threshold triggered 4 : Critical high threshold triggered	-	RO
PDU.OutletSystem.Outlet[x].PresentStatus.SwitchOnOff	Measure	0: Outlet not powered 1: Outlet powered	-	RO
PDU.OutletSystem.Outlet[x].Type	Constant	Types of PDU outlets: unknown (0), iecC13 (1), iecC19 (2), uk (10), french (11), schuko (12), nema515 (20), nema51520 (21), nema520 (22), nemaL520 (23), nemaL530 (24), nema615 (25), nema620 (26), nemaL620 (27), nemaL630 (28), nemaL715 (29), rf203p277 (30)	-	RO
PDU.PowerSummary.ChangedStatus.CommunicationLost	Timestamp	Communication intra modules have failed.	s	RO
PDU.PowerSummary.ConfigActivePower	Constant	PDU Nominal Active Power	W	RO
PDU.PowerSummary.ConfigCurrent	Constant	PDU PDU total rating current.	mA	RO
PDU.PowerSummary.ConfigVoltage	Constant	PDU rating voltage.	V	RO
PDU.PowerSummary.DelayBeforeShutdown	Command	Delay before the outlets of the PDU shutdown. 1 to n: Delayed action 0 : Immediat action -1: Cancel/No action	s	RW
PDU.PowerSummary.DelayBeforeStartup	Command	Delay before the outlets of the PDU restart. 1 to n: Delayed action 0 : Immediat action -1: Cancel/No action	s	RW
PDU.PowerSummary.EWEntity.Importance	Parameter	Energy Wise Importance	-	RW
PDU.PowerSummary.EWEntity.Keyword	String[31]	Energy Wise Keyword	-	RW
PDU.PowerSummary.EWEntity.Level	Parameter	Energy Wise Level	-	RO
PDU.PowerSummary.EWEntity.Role	String[31]	Energy Wise Role	-	RW
PDU.PowerSummary.iManufacturer	String[31]	Manufacturer Name.	-	RO

Table 8. ePDU CLI Objects (Continued)

XML Object Name	Type	Description	Unit	Access
PDU.PowerSummary.iName	String[31]	Unit friendly name.	-	RW
PDU.PowerSummary.iPartNumber	String[15]	Part Number.	-	RO
PDU.PowerSummary.iProduct	String[63]	Product Name.	-	RO
PDU.PowerSummary.iReferenceNumber	String[31]	Technical Reference of firmware.	-	RO
PDU.PowerSummary.iSerialNumber	String[15]	Serial Number.	-	RO
PDU.PowerSummary.iVersion	String[15]	F/W Version.	-	RO
PDU.PowerSummary.OverTemperature[3].Threshold	Parameter	Threshold	d°K	RW
PDU.PowerSummary.OverTemperature[4].Threshold	Parameter	Threshold	d°K	RW
PDU.PowerSummary.PDUType	Constant	Feature Topology of the PDU: 0: Unknown 1: SW (Switched) 2: MO (Metered Outlet) 3: MA (Managed) 4: MI (Metered Input) 5: IL (In-Line Metered))	-	RO
PDU.PowerSummary.PresentStatus.CommunicationLost	AlarmL1	Communication intra modules have failed.	-	RO
PDU.PowerSummary.PresentStatus.OverTemperature	AlarmL1	0 : No threshold triggered 1 : Warning low threshold triggered 2 : Critical low threshold triggered 3 : Warning high threshold triggered 4 : Critical high threshold triggered	-	RO
PDU.PowerSummary.Temperature	Measure	Internal Temperature.	d°K	RO
PDU.PowerSummary.Time	Measure	Unix timestamp that is refreshed from the RTC.	s	RW
PDU.PowerSummary.Timer	Measure	Time elapsed since the 1st start of the device.	s	RO

Table 9. System CLI Objects

XML Object Name	Access right	Type	Description	Access	Default Value
System.Bootloader.iVersion	admin	String:15		RO	""
System.Bootloader.Mode	superadmin	BootMode	0: Normal 1: Upgrade 2: Passthru 3: ATE 4: Bootstrap	RW	0
System.Contact	admin	String:31		RW	""
System.DaisyChain.Count	admin	Integer0to65535		RO	1

Table 9. System CLI Objects (Continued)

XML Object Name	Access right	Type	Description	Access	Default Value
System.DaisyChain.Deviceld	admin	DaisyChainDeviceld	0: Host 1: Device 1 2: Device 2 3: Device 3	RW	1
System.DaisyChain.Position	admin	DaisyChainPosition	0: Middle 1: End	RW	0
System.DaisyChain.Status	admin	DaisyChainStatus	0: No Communication 1: Communication OK 2: Communication failed 3: Host conflict 4: Device conflict	RO	0
System.DaisyChain[x].Deviceld	admin	DaisyChainDeviceld	0: Host 1: Device 1 2: Device 2 3: Device 3	RO	1
System.DaisyChain[x].MacAddress	admin	String:17		RO	"00:00:00:00:00:00"
System.DaisyChain[x].Position	admin	DaisyChainPosition	0: Middle 1: End	RO	0
System.DaisyChain[x].Status	admin	DaisyChainStatus	0: No Communication 1: Communication OK 2: Communication failed 3: Host conflict (not implemented) 4: Device conflict	RO	0
System.Display.Contrast	admin	Integer0to63		RW	37
System.Display.Language	superadmin	DisplayLanguage	0: English 1: French 2: German 3: Spanish 4: Russian 5: Portuguese 6: Italian	RW	0
System.Display.LcdRotation	admin	LcdRotation	0: Rotation 0 Deg (OU) 1: Rotation 90 Deg (IL) 2: Rotation 180 Deg (OU) 3: Rotation 270 Deg (IL)	RW	0
System.Display.Password	superadmin	Password:4		RW	"1234"
System.Display.Password.IsEnable	superadmin	ControlState		RW	0
System.EepromBackup.Reset	superadmin	ControlState		WO	0
System.EepromBackup.Statistic	admin	String:31		RO	""

Table 9. System CLI Objects (Continued)

XML Object Name	Access right	Type	Description	Access	Default Value
System.Email.Count	admin	Integer0to65535		RO	NB_EMAIL_NOTIFICATIONS
System.Email.Sender	admin	String:31		RW	"PDU@hEaton.com"
System.Email[x].Description	admin	String:63		RW	" "
System.Email[x].EventList.All	admin	EventType	0: None 1: All Alarms	RW	0
System.Email[x].Events.Log	admin	ControlState	0: Disabled 1: Enabled	RW	0
System.Email[x].Recipient	admin	String:127		RW	"email1@recipient.com email2@recipient.com email3@recipient.com email4@recipient.com email5@recipient.com email6@recipient.com email7@recipient.com email8@recipient.com email9@recipient.com"
System.Email[x].Report.Hour	admin	Time0to23hours		RW	0
System.Email[x].Report.Next	admin	Time0to31days		RW	0
System.Email[x].Report.Periodicity	admin	Time0to99days		RW	0
System.Email[x].Selected	admin	ControlState	0: Disabled 1: Enabled 2: Deleted	RW	0
System.Email[x].Test	admin	Boolean		WO	0
System.Ethernet.iSerialNumber	admin	String:31		RO	""
System.Ethernet.iVersion	admin	String:15		RO	"00.00.0b24"
System.Ethernet.iVersion	admin	String:15		RO	"01.00.0019"
System.Ethernet.MacAddress	admin	String:31		RO	"00:00:00:00:00:00"
System.Ethernet.Mode	admin	EthMode	0: Auto Negotiation 1: 100 Mbps Full Duplex 2: 100 Mbps Half Duplex 3: 10 Mbps Full Duplex 4: 10 Mbps Half Duplex	RW	0
System.FactoryReset	admin	Boolean		WO	0
System.FirmwareUpgrade	admin	Boolean		RW	1
System.FirmwareUpgradeMode	admin	ControlState	0: Disabled 1: Enabled	WO	0
System.FormatFS	superadmin	ControlState	0: Disabled 1: Enabled	WO	0
System.KeepIP	admin	ControlState	0: Disabled 1: Enabled	RW	0

Table 9. System CLI Objects (Continued)

XML Object Name	Access right	Type	Description	Access	Default Value
System.Language	admin	Language	2: English (ENG) 3: French (FRE) 4: Spanish (SPA) 5: German (GER) 6: Italian (ITA) 7: Chinese Simplified (CHI) 8: Japanese (JPN) 9: Korean (KOR) 10: Chinese Traditional (CHT) 11: Russian (RUS) 12: Portuguese (POR) 13: Czech (CZE) 14: Polish (POL)	RW	2
System.Location	admin	String:31		RW	""
System.Login	superadmin	String:15		RW	"admin"
System.LogReset	admin	Boolean		WO	0
System.Network.Authentication.AuthMethod	admin	AuthMethod	1: Local Authentication 2: LDAP Authentication 3: Radius Authentication	RW	1
System.Network.Authentication.AuthOrder	admin	AuthOrder	1: Local 2: External then Local 3: Local then External 4: External	RW	1
System.Network.Authentication.MaxSessionTime	admin	Integer0toFFFFFFFF		RW	0xFFFFFFFF
System.Network.Authentication.SessionTime	admin	Integer0toFFFFFFFF		RW	300
System.Network.DHCP	admin	ControlState	0: Disabled 1: Enabled	RW	1
System.Network.DomainName	admin	String:63		RW	"pdu.domain.com"
System.Network.EnergyWise.Cmd	admin	EnergyWiseCmd	2: Start 3: Stop 4: Restart	WO	0
System.Network.EnergyWise.Domain	admin	String:63		RW	"Eaton"
System.Network.EnergyWise.Enable	admin	ControlState	0:Disable 1:Enable	RW	0
System.Network.EnergyWise.ListenPort	admin	Integer1to65535		RW	48296
System.Network.EnergyWise.RemotePort	admin	Integer1to65535		RW	43440
System.Network.EnergyWise.SdkVersion	admin	String:31		RO	"RELEASE 1.2.0"
System.Network.EnergyWise.Secret	admin	ControlState		RW	1
System.Network.EnergyWise.SecretKey	admin	Password:63		RW	"Eaton"

Table 9. System CLI Objects (Continued)

XML Object Name	Access right	Type	Description	Access	Default Value
System.Network.EnergyWise.SeqId	admin	Integer0toFFFFFFFF		RW	0
System.Network.EnergyWise.State	admin	String:31		RO	""
System.Network.EnergyWise.ThresholdLevel	admin	Integer0to10		RW	4
System.Network.FTP.Access	admin	ControlState	0: Disabled 1: Enabled	RW	1
System.Network.HostName	admin	String:31		RW	"PDU\$x"
System.Network.HTTP.Access	admin	ControlState	0: Disabled 1: Enabled	RW	1
System.Network.HTTP.Port	admin	Integer1to65535		RW	80
System.Network.HTTP.RefreshRate	admin	Integer0to128		RW	10
System.Network.HTTPS.Port	admin	Integer1to65535		RW	443
System.Network.IPAddress	admin	IPv4		RW	"192.168.123.123"
System.Network.IPGateway	admin	IPv4		RW	""
System.Network.IPMask	admin	IPv4		RW	"255.255.0.0"
System.Network.IPv6Address1	admin	IPv6		RW	""
System.Network.IPv6Address2	admin	IPv6		RO	""
System.Network.IPv6AutoConfig	admin	ControlState	0: Disabled 1: Enabled	RW	0
System.Network.IPv6DefaultGateway	admin	IPv6		RW	""
System.Network.IPv6Enable	admin	ControlState	0: Disabled 1: Enabled	RW	0
System.Network.IPv6LocalAddress	admin	IPv6		RO	""
System.Network.IPv6Status	admin	NetworkIpv6Status	0: Invalid 1: Valid 2: Manual Configuration	RO	0
System.Network.Ldap.AuthMechanism	admin	LdapAuthMechanism	0: Simple 7: Digest MD5	RW	0
System.Network.Ldap.CheckServerCertificat	admin	ControlState		RW	0
System.Network.Ldap.GroupSearch.AuthzMode	admin	LdapAuthorizationMode	0: No Authorization 1: By User Attribute 2: By Group	RW	0
System.Network.Ldap.GroupSearch.BaseDn	admin	String:249		RW	""
System.Network.Ldap.GroupSearch.UPSGroupNameAttr	admin	String:49		RW	""
System.Network.Ldap.GroupSearch.UserNameAttr	admin	String:49		RW	""
System.Network.Ldap.SearchMode	admin	LdapSearchMode	0: Anonymous Search 1: User Bind Search	RW	0
System.Network.Ldap.SearchUser	admin	String:249		RW	""
System.Network.Ldap.SearchUserPassword	admin	Password:49		RW	""
System.Network.Ldap.Server.Count	admin	Integer0to10	2	RO	2

Table 9. System CLI Objects (Continued)

XML Object Name	Access right	Type	Description	Access	Default Value
System.Network.Ldap.Server[x].IsEnable	admin	ControlState	0: Disabled 1: Enabled	RW	0
System.Network.Ldap.Server[x].Port	admin	Integer1to65535		RW	389
System.Network.Ldap.Server[x].ServerName	admin	String:49		RW	"LDAP Server1 LDAP Server2"
System.Network.Ldap.Server[x].TimeOut	admin	Integer0to65535		RW	10
System.Network.Ldap.ServerType	admin	LdapServerType	0: Generic LDAP server 1: Active Directory	RW	0
System.Network.Ldap.SSLMode	admin	LdapSSLMode	0: No SSL 1: SSL (LDAPS) 2: SSL (Start TLS)	RW	0
System.Network.Ldap.UserSearch.Attribute	admin	String:49		RW	""
System.Network.Ldap.UserSearch.BaseDn	admin	String:99		RW	""
System.Network.Ldap.UserSearch.Object	admin	String:49		RW	""
System.Network.PrefixLength1	admin	Integer0to128		RW	0
System.Network.PrefixLength2	admin	Integer0to128		RO	0
System.Network.PrimaryDNS	admin	IPv4		RW	""
System.Network.Radius.AuthType	admin	RadiusAuthType	0: PAP 1: CHAP	RW	0
System.Network.Radius.Server.Count	admin	Integer0to10		RO	2
System.Network.Radius.Server[x].IsEnable	admin	ControlState		RW	0
System.Network.Radius.Server[x].NasIdentifierType	admin	NasIdentifierType	0: IDENTIFER_IPV4 1: IDENTIFER_IPV6_1 2: IDENTIFER_IPV6_2 3: IDENTIFER_IPV6_LOCAL	RW	0
System.Network.Radius.Server[x].Port	admin	Integer1to65535		RW	1812
System.Network.Radius.Server[x].Retry	admin	Integer0to255		RW	3
System.Network.Radius.Server[x].ServerName	admin	String:49		RW	"RADIUS Server1 RADIUS Server2"
System.Network.Radius.Server[x].SharedSecret	admin	Password:49		RW	""
System.Network.Radius.Server[x].Timeout	admin	Integer1to65535		RW	5
System.Network.SecondaryDNS	admin	IPv4		RW	""
System.Network.SntpServer.Authentication	admin	ControlState	0: Disabled 1: Enabled	RW	0
System.Network.SntpServer.HostName	admin	String:63		RW	""
System.Network.SntpServer.Login	admin	String:31		RW	""
System.Network.SntpServer.Password	admin	Password:31		RW	""
System.Network.SntpServer.Port	admin	Integer1to65535		RW	25
System.Network.SNMP.Port	admin	Integer1to65535		RW	161

Table 9. System CLI Objects (Continued)

XML Object Name	Access right	Type	Description	Access	Default Value
System.Network.SNMP.snmpVersion	admin	SNMPVersion	0: disabled 1: SNMP V1 2: SNMP V3 3: SNMP V1&V3	RW	0
System.Network.SNMP.TrapPort	admin	Integer1to65535		RW	162
System.Network.SNMP.V1.User.Count	admin	Integer0to65535		RO	SNMPV1_NBCOMMUNITIES
System.Network.SNMP.V1.User[x].SecurityRight	admin	Snmpv3VacmSecurityRight	0: No Right 1: Read-Only 2: Read/Write 3: Number	RW	0
System.Network.SNMP.V1.User[x].UserName	admin	String:31		RW	"public private"
System.Network.SNMP.V3.User.Count	admin	Integer0to65535		RO	SNMPV3_USM_NBUSERS
System.Network.SNMP.V3.User[x].Name	admin	String:31		RW	"SNMPv3 User 1 SNMPv3 User 2 SNMPv3 User 3 SNMPv3 User 4"
System.Network.SNMP.V3.User[x].Password	admin	String:24		RW	" "
System.Network.SNMP.V3.User[x].PrivacyKey	admin	String:24		RW	" "
System.Network.SNMP.V3.User[x].SecurityLevel	admin	Snmpv3UsmLevel	0: Not Set 1: No Auth No Priv 2: Auth No Priv 3: Auth Priv	RW	0
System.Network.SNMP.V3.User[x].SecurityRight	admin	Snmpv3VacmSecurityRight	0: No Access 1: Read-Only 2: Read/Write	RW	0
System.Network.SSH.Port	admin	Integer1to65535		RW	22
System.Network.Syslog.Server.Count	admin	Integer0to10		RO	2
System.Network.Syslog.Server[x].BOM	admin	ControlState		RW	1

Table 9. System CLI Objects (Continued)

XML Object Name	Access right	Type	Description	Access	Default Value
System.Network.Syslog.Server[x].Facility	admin	SyslogFacility	0: kernel messages 1: user-level messages 2: mail system 3: system daemons 4: security/authorization messages 5: messages generated internally by syslogd 6: line printer subsystem 7: network news subsystem 8: UUCP subsystem 9: clock daemon 10: security/authorization messages 11: FTP daemon 12: NTP subsystem 13: log audit 14: log alert 15: clock daemon (note 2) 16: local use 0 (local0) 17: local use 1 (local1) 18: local use 2 (local2) 19: local use 3 (local3) 20: local use 4 (local4) 21: local use 5 (local5) 22: local use 6 (local6) 23: local use 7 (local7)	RW	1
System.Network.Syslog.Server[x].IsEnable	admin	ControlState		RW	0
System.Network.Syslog.Server[x].MessageTransfer	admin	SyslogMessageTransfer	0: Octet Counting 1: Non Transparent Framing	RW	0
System.Network.Syslog.Server[x].Port	admin	Integer1to65535		RW	514
System.Network.Syslog.Server[x].Protocol	admin	SyslogProtocol	0: UDP 1: TCP	RW	0
System.Network.Syslog.Server[x].ServerName	admin	String:49		RW	"Syslog Server1 Syslog Server2"
System.Network.Syslog.Server[x].Test	admin	Boolean		WO	0
System.Network.Telnet.Access	admin	ControlState	0: Disabled 1: Enabled	RW	1
System.Network.Telnet.Console	admin	ConsoleHMI	0: Menu 1: CLI	RW	0

Table 9. System CLI Objects (Continued)

XML Object Name	Access right	Type	Description	Access	Default Value
System.Network.Telnet.Port	admin	Integer1to65535		RW	23
System.Network.Telnet.Security	admin	ControlState	0: Disabled 1: Enabled	RW	0
System.NetworkManagementSystem.Count	admin	Integer0to65535		RO	NB_TRAP_RECEIVE RS
System.NetworkManagementSystem[x].EventList.All	admin	EventType	0: None 1: All Alarms	RW	0
System.NetworkManagementSystem[x].HostName	admin	String:63		RW	" "
System.NetworkManagementSystem[x].Name	admin	String:31		RW	"Trap Receiver 1 Trap Receiver 2 Trap Receiver 3 Trap Receiver 4 Trap Receiver 5 Trap Receiver 6 Trap Receiver 7 Trap Receiver 8"
System.NetworkManagementSystem[x].Test	admin	Boolean		WO	0
System.NetworkManagementSystem[x].TrapCommunity	admin	String:31		RW	"public public public public public public public public"
System.NetworkManagementSystem[x].TrapSnmpVersion	admin	TrapSNMPVersion	0: Disabled 1: SNMP V1 2: SNMP V3	RW	0
System.Outlet[x].Protected.HostName		String:31		RW	
System.Outlet[x].Protected.Name		String:31		RW	
System.Outlet[x].Protected.Version		String:10		RW	
System.Outlet[x].ShutdownDuration		Integer0to65535		RW	0
System.Password	superadmin	Password:15		RW	"admin"
System.Restart	admin	Boolean		WO	0
System.Security	admin	ControlState	0: Disabled 1: Enabled	RW	0
System.Slip.Statistic	admin	String:31		RO	""
System.Temperature.Unit	admin	TemperatureUnit	1: °C 2: °F	RW	1
System.Time	admin	Time0to136years		RW	0
System.TimeDaylight	admin	ControlState	0: Disabled 1: Enabled	RW	0
System.TimeFormat	admin	DateTimeFormat	1: mm/dd/yyyy 2: dd/mm/yyyy 3: yyyy-mm-dd 4: dd mm yyyy	RW	2
System.TimeNtp	admin	String:63		RW	""

Table 9. System CLI Objects (Continued)

XML Object Name	Access right	Type	Description	Access	Default Value
System.TimeSync	admin	DateTimeSource	0: Manual 1: Sync NTP	RW	0
System.TimeUp	admin	Time0to136years		RO	0
System.TimeZone	admin	DateTimeTimeZone		RW	0
System.User.Count	admin	Integer0to65535		RW	MAX_NB_USERS
System.User[x].Login	admin	String:15		RW	"Account 1 Account 2 Account 3 Account 4 Account 5 Account 6 Account 7 Account 8"
System.User[x].Password	admin	Password:15		RW	" "
System.User[x].Profile	admin	MultiUserProfile	0: superadmin 1: admin 2: PDU User 3: Outlet User	RW	0
System.User[x].SecurityRight	admin	MultiUserAccess	0: No Access 1: Read-Only 2: Read/Write	RW	0
System.User[x].Status	admin	ControlState	0: Disabled 1: Enabled	RW	0
System.User[x].Type	admin	MultiUserType	0: local 1: remote	RW	0

Chapter 8 Web Interface Operation

This chapter describes remotely configuring, managing, and monitoring an Eaton Enclosure Power Distribution Unit (ePDU) G3 remotely through the ePDU Network Management and Control (eNMC) module Web interface. This chapter describes the following:

- Navigating the Web interface
- Accessing the Web interface
- Configuring settings and monitoring the ePDU



NOTE When the Web browser is set to 100% (full page), we recommend setting your screen resolution to a minimum of 1024 x 768 for the best display performance.

Navigating the Web Interface

The graphical Web interface is used to remotely monitor or configure the ePDU (see Figure 70). The Web interface that corresponds to the ePDU topology type displays. This section describes the functions provided by this interface.

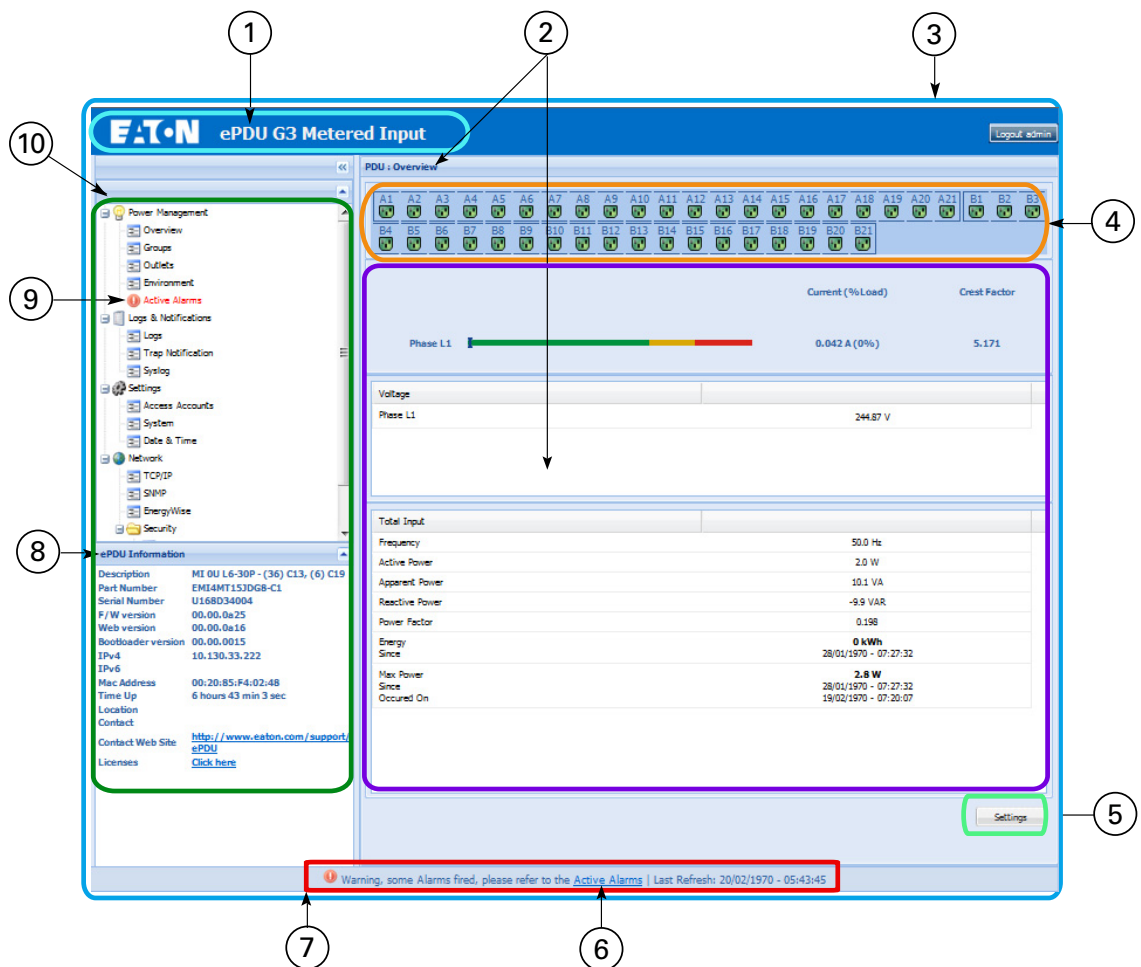

Figure 70. Navigating the Web Interface (Opening Page)

Table 10 provides descriptions of the Web interface components.

Table 10. Web Interface Region Descriptions







Area	Description
1 - Application Header Bar	The header bar identifies which Eaton ePDU Web application is within the host window (Managed [MA], Metered Input [MI], Metered Outlet [MO], In-Line Metered [IL], or Switched [SW]).
2 - Menu Selection Page Display	<p>As each menu link is selected, the corresponding information displays as the main page. The top of the page displays the menu selection title.</p> <p>NOTE You can expand your view of the contents vertically using the elevator scroll button on the side of the page. If you need more window viewing area, resize the Host Window to a wider or taller size. This enlarges the main page.</p>
3 - Host Window	The host window is the page where the application resides. Both the height and the width of the host window can be resized. The application panels resize at the same time. An elevator scroll button displays on the side of the application panel if the panel cannot display the entire list within the resized panel. Drag the elevator scroll button up or down to view the entire list of data in the application panel.
4 - Outlet Icons	<p>Roll over any outlet icon to see the type of outlet and whether there is an alarm. (A gray outlet status indicates that the outlet management feature could be damaged.)</p> <p>Outlet is Off</p>  <p>Outlet is on</p> 
5 - Operation Buttons and Icons	Operation buttons and icons are provided to save data entries and updates. Enter data by typing or selecting entries and clicking the associated button. Some pages have buttons for specialized functions, such as clearing accumulated data logs. File operation icons are also provided to save or download files.
6 and 7- Current Alarms (when active)	<p>An indicator appears as a notification in the refresh bar at the bottom of the page. For example, "Warning, some alarms fired, please refer to the Active Alarms Last Refresh: dd/mm/yyyy - hh:hh:ss"</p> <p>The words "Active Alarms" in the alarm notification sentence link to the Active Alarms page.</p> <p>The following symbols indicate the alarm level when an alarm threshold setting is exceeded:</p> <p>Active Alarms Present</p>  <p>High Critical Threshold Alarm</p>  <p>High Warning Threshold Alarm</p>  <p>Low Warning Threshold Alarm</p> 

Table 10. Web Interface Region Descriptions (Continued)

Area	Description
8 - ePDU Information	This panel displays identification information for the ePDU that is providing data. The data fields include information about the ePDU, including a model description, part number, serial number and the current ePDU firmware version in use. NOTE For daisy-chained ePDUs, you can select either ePDU [0] for Host data and ePDU [1], [2], or [3] for Device data.
9- Active Alarms Menu Selection	This indicator alerts you to the presence of currently active system alarms. It is in the menu hierarchy. When alarms are active, the text for Active Alarms is red. Selecting Active Alarms opens the Active Alarms page and displays the current active alarms.
10 - Menu Bar	The menu bar on the left panel contains links to pages for configuring the system or managing and monitoring the ePDU. The menu hierarchy is expandable and collapsible. You can move the menu bar out of view using the horizontal scrolling tab at the bottom of the page. Click any selection in the menu bar to retrieve ePDU performance data, review operation log information, or retrieve system or network configuration settings. The data on the selected page is presented in table format.

NOTE 1 The data that displays on the Web interface depends on the ePDU model you are using. For example, a dual reporting window displays data for Input 1 and for Input 2 when the ePDU has two inputs. In this chapter, the examples shown represent typical data displays reported from a single-input model.



NOTE 2 The Web interface supports Microsoft® Internet Explorer® 8.0 and greater, Firefox® (installed on Linux® or Windows®), and Google® Chrome®.

NOTE 3 On most pages, you can display relevant tooltips as you roll over images and fields.

Languages

The Web interface language is configurable. The following languages are available for your selection:

- English
- French
- Spanish
- German
- Italian
- Chinese Simplified
- Japanese
- Korean
- Chinese Traditional
- Russian
- Polish
- Portuguese
- Czech

Accessing the Web Interface

The Web interface can be accessed using a standard Web browser.



NOTE

The ePDU defaults to using DHCP when delivered. If you are unable to connect to the ePDU through the network connection with this default address, see “Network Communication Configuration” on page 38 for more information.

To access the Web interface:

1. Open the Web browser.
2. Enter a new ePDU IP address or select the previously entered ePDU IP address from the URL address drop list. The Authentication dialog displays.
3. Enter a valid user name and password in the Authentication dialog box (see Figure 71). Click **Login** to continue or **Cancel** to exit.



NOTE

The default user name is “admin” and the default password is “admin.”

Figure 71. Login Authentication

4. The ePDU Overview page displays.
5. To access another page to observe and control the ePDU, click any selection in the menu bar. The page that corresponds to your menu selection opens and displays in the main selection page window.

Menu Selections

Depending on the permission level of the user, the Menu Bar provides up to four groups of selections:

- Power Management
 - Overview
 - ePDU [0] See NOTE 1
 - ePDU [1] See NOTE 1
 - ePDU [2] See NOTE 1
 - ePDU [3] See NOTE 1
 - Groups
 - Outlets
 - Environment
 - Active Alarms

- Logs and Notifications
 - Logs
 - Trap Notification
 - Syslog
- Settings See NOTE 2
 - User-Defined Groups
 - Access Accounts
 - System
 - Date & Time
- Network
 - TCP/IP
 - SNMP
 - Security
 - Global
 - LDAP
 - RADIUS

NOTE 1 Menu selections for ePDU [0], [1], [2], or [3] only display if the ePDUs are configured in a daisy-chained configuration. If provided, selecting either ePDU [0] or ePDU [1], [2], or [3] displays the Overview page for the specified ePDU only.



NOTE 2 The Settings menu is different from the Settings button. Selecting the **Settings** button on any power management page displays a separate window that allows you to change settings, such as alarm thresholds.

NOTE 3 See “Access Privileges” on page 99 for more information about levels of access privileges.

Power Management

Use the Power Management menu selections to see up-to-date operating measurements on the ePDU Overview page. This page provides the present readings for the ePDU that is reporting data. (If ePDUs are daisy-chained, you can select to see Host or Device ePDU Information.) The readings are reported per phase and, for 3Ph ePDU models, all phases. This page includes data such as current, voltage, and crest factor. The outlet icons are green if the outlet is on and red if the outlet is off. Roll over the icon to see the outlet type and status.

You can select the Outlets or Groups page to manage outlets or groups of outlets. These pages provide present measurements or readings such as current or active power. You can set measurement thresholds for alarm or warning notifications as well.

The Environment menu selection provides humidity and temperature data if you have an EMP installed. You can set measurement thresholds for alarm or warning notifications as well. It also provides open or closed status for two dry contacts.

You can check current alarms on the Active Alarms page to see a list of alarms by date, time, and description. See “Maintenance and Alarms” on page 127 for a list of alarms.

Logs & Notifications

Use the Logs & Notifications menu selections to see a list of the most recent events (Logs page). You can set trap receivers (Trap Notification page) and you can also view Syslog information.

Settings

The Settings menu selections that display depend on the type of privilege you have. These selections allow you to configure administrative settings, system attributes, and network access and control. Depending on privilege, this menu can include the following:

- **User-Defined Groups:** A user-defined group consists of a group of outlets that are logically linked together on the same ePDU or on a different ePDU. Outlets that are in the same user-defined group can be turned on, turned off, rebooted and scheduled in a synchronized manner. Power schedules are attached to outlets, and a power schedule can be programmed for each outlet.
- **Access Accounts:** The Access Accounts page allows you to set up the SuperUser, local or remote administrators, local ePDU-users/outlet users, and remote ePDU-users/outlet users as individuals or groups. Access Accounts also allows the SuperUser to set up the LCD password.
- **System:** Use the System selection for identifying the administrator contact information, uploading an ePDU or ePDU Network Management and Control (eNMC) module configuration file, upgrading, restarting, or restoring factory default configuration to the ePDU eNMC module. You can also reset the language and configure reporting for the EMP.
- **Date & Time:** The Date & Time page allows you to select the date format and set the date and time, either manually or by synchronizing with the NTP (Network Time Protocol) server. You can set the time zone and have the option of allowing DST (Daylight Savings Time).

Network

This selection allows you configure TCP/IP, SNMP, and Security settings for this ePDU.

- **TCP/IP:** Use this page to configure Ethernet, IPv4, IPv6, DNS, and SMTP.
- **SNMP:** Use this page to configure general SNMP settings, SNMPv1 settings, and SNMPv3 settings. You can also access the Eaton ePDU MIB (Management Information Base) from this page.
- **Security:** Use this page to set port settings and LDAP (Lightweight Directory Access Protocol) settings.
 - **Global:** Set the port settings and the authentication mode on this page.
 - **LDAP:** Set the LDAP search configuration and global LDAP server global parameters for the specified LDAP servers on this page.
 - **RADIUS:** Add or edit the parameters for a primary or secondary RADIUS server on this page.

Access Privileges

The level of access privilege determines what the user will see and what actions the user can perform. For example, the level of access privilege determines which menu items the user can access or which fields display on individual setting and configuration dialogs. Any menu or dialog functions that are not included in the access privilege set for a user do not display, or are they are grayed-out.

These accounts can be configured not only for individuals, but also for groups. All remote users and administrators belong to a remote group and their access privileges are defined from this group. Remote accounts also provide a way to attach LDAP users (see "Configure Remote Group Access" on page 112).

Three user roles can be assigned these access privilege levels:

- Administrator
- Local or Remote ePDU-User
- Local or Remote ePDU-User/Outlet User

Administrator

There can be one SuperUser and up to eight standard local or remote administrators.

Only one user can be the SuperUser Administrator. This defaults to the local user, but a SuperUser should be assigned at first connection. This account is not accessible or editable by the standard administrators or ePDU-Users/Outlet Users. The SuperUser always has read-write privileges to view and edit all data, plus the following privileges restricted only to the SuperUser:

- Exclusive access to modify the SuperUser account settings
- Can upload the communication module configuration file or upgrade the firmware
- Can access both the Serial interface and the Web interface
- Exclusive access to the Network and Date and Time Settings menu

**NOTE**

The default Administrator login and password is “admin” and should be changed at the first connection. If the administrator loses the password or login, contact your service representative to recover it.

Local or Remote Administrator

Up to eight standard administrators (local or remote) can be assigned. Only accessible menu items display for the user according to the assigned permissions.

**NOTE**

This menu indicates the two ePDU are daisy-chained, one host (ePDU [0]) and one device ePDU (ePDU [1]).

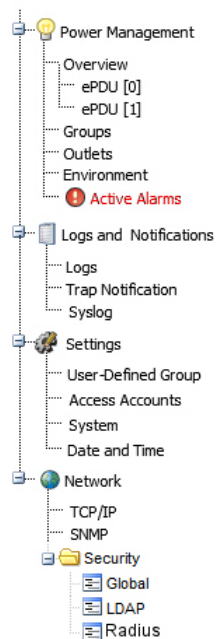

Figure 72. Administrator Menu View

Read-Write Access

A local or remote administrator who is assigned read-write access can perform the following:

- Access to up-to-date ePDU data and measurements
- Create, modify, or disable an administrator or user account except for the SuperUser
- Create, modify, or disable User-Defined Groups
- Configure e-mail recipient addresses for e-mail notification to users
- Restart the communications module
- Cannot access the Serial interface; must use the Web interface only
- Access all menus on the Web interface
- Access to retrieved ePDU up-to-date data and measurements
- Clear logs
- **Local Administrator Only.** Can switch on bootloader mode and upgrade firmware.

Read-Only Access

A local or remote administrator with read-only access has limited privileges, including:

- Access to up-to-date ePDU data and measurements
- Has the authority to change the password, but not the login (Remote ePDU-Users cannot change the login or password)
- Cannot access the Serial interface; must use the Web interface only
- Can access the log and notifications submenu, but cannot clear the logs data
- Cannot configure the TCP/IP, SNMP Global Security, and LDAP settings

No Access

An administrator with no access is not authorized to access to the Web page.

ePDU-User**Read-Write Access**

A local or remote ePDU-User with read-write access privileges has access to the same functions as the administrator, except this user cannot change the account configuration for another user, such as e-mail addresses for notifications.

Only accessible menu items display for the user according to the assigned permissions.

**NOTE**

This menu indicates the two ePDU are daisy-chained, one host (ePDU [0]) and one device ePDU (ePDU [1]).

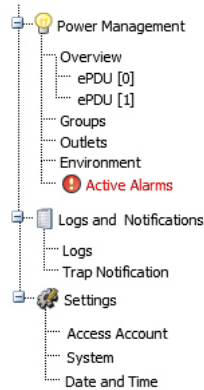

Figure 73. ePDU-User Menu View

Read-Only Access

An ePDU-User with read-only access has limited privileges, including:

- Access to up-to-date ePDU data and measurements
- Has the authority to change the password and e-mail address, but not the login (Remote ePDU-Users cannot change the login or password, but can change their own e-mail address.)
- Cannot access the Serial interface; must use the Web interface only
- Can access the log and notifications submenu, but cannot clear the logs data
- Cannot configure the TCP/IP, SNMP Global Security, and LDAP settings
- Cannot upload the communication module configuration file or upgrade the firmware
- Cannot change his profile or another user's account

No Access

An ePDU-User with no access privileges is not authorized to access to the Web page.

Outlet-User

The Outlet-Users have only one read-write privilege. The Outlet-User has the authority to change his own password and e-mail address, but not the login. (Remote Outlet-Users cannot change the login or password, but can change their own e-mail address.) All other privileges are restricted to viewing ePDU and assigned outlets data. Only accessible menu items display for the user according to the assigned permissions.

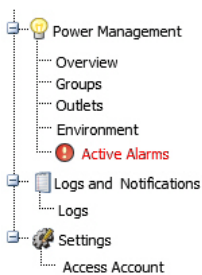

Figure 74. Outlet-User Menu View

Read-Only Access

Outlet-Users with read-only access have limited privileges, including:

- Access to retrieved ePDU up-to-date data and measurements, but cannot change settings for the ePDU
- Access to retrieved data for the outlets in user-defined groups assigned by the administrator
- Cannot access the Serial interface; must use the Web interface only
- Can access the log and notifications submenu, but cannot clear the logs data
- Cannot configure the TCP/IP, SNMP Global Security, and LDAP or other global settings
- Cannot upload the communication module configuration file or upgrade the firmware
- Cannot change his profile or another user's account

No Access

An Outlet-User (local or remote) with no access privileges is not authorized to access to the Web page.

Session Management

The following session management restrictions apply:

- There can only be one SuperUser with read-write access rights and up to eight multi-users with configurable access rights.
- Only one ePDU-User or Outlet User with read-write access and at least one common outlet can be logged-in at a time.
- When the administrator connects, any existing read-write sessions are closed. The other user (or users) will be asked to authenticate and open a new read-only session.
- If a user with read-write access is logged in and another user with read-write access wants to log in, the following message displays: "Another user is logged in with R/W access. Continue as R/O?"
- ePDU sessions are also limited in the following ways:
 - Only five standard sessions without SSL (Secure Sockets Layer) or SSH (Secure Shell) sockets are allowed.
 - Only two secure sessions can be running at the same time.
 - Only an administrator can have two simultaneous sessions open in HTTP/HTTPS (Hypertext Transfer Protocol / Hypertext Transfer Protocol Secure), Telnet/SSH.

**NOTE**

During an HTTP/HTTPS or Telnet/SSH session, the session times out if there is no activity for five minutes. After a session times out, you must login again.

Overview**Review/Modify ePDU Data****NOTE**

Menu selections for ePDU [0], [1], [2], or [3] only display if the ePDUs are configured in a daisy-chained configuration. If provided, selecting either ePDU [0] or ePDU [1], [2], or [3] displays the Overview page for the specified ePDU only.

1. Access the Web interface and log in.
2. The PDU: Overview page displays.
3. In the ePDU Information panel, review ePDU identification information.

- In the main page, review ePDU monitoring data.

**NOTE**

The phase information that displays reflects the ePDU model. For example, the number of phases that display depends on whether the ePDU is a single-phase, split-phase, or three-phase model. The phase labels also change depending on whether the model is a delta-wired or a wye-wired model.

**NOTE**

Roll the cursor over an outlet icon to see the type of outlet and the status (On or Off).

- To modify ePDU voltage and current threshold values, click the **Settings** button. The Settings dialog displays.
 - To enter new threshold values, type new values in any of the text boxes that follow, then click **Save**:
 - Low warning current threshold
 - High warning current threshold
 - High critical current threshold
 - Low critical voltage threshold
 - Low warning voltage threshold
 - High warning voltage threshold
 - High critical voltage threshold
 - To reset the threshold values to the default values, click **Default**, then click **Save**.
 - To reset a kWh (kilowatt hour) counter to zero, click **Reset kWh**, then click **Save**.
-

**NOTE**

If you do not save the action, the kWh counter remains unchanged.

- To reset the maximum power counter to zero, click **Reset Max Power**, then click **Save**.
- To cancel this action and return to the Overview page, click **Cancel**.

Groups

**NOTE**

In the toolbar, **Turn On/Off Groups** will only appear for Switched and Managed ePDUs.

Review/Modify ePDU Groups

- Access the Web interface and log in.
 - Under Power Management, select Groups. The Groups page displays.
 - Review basic monitoring information for Groups measurement settings.
-

**NOTE**

Click the red arrow next between the Current (%Load) and the voltage columns to see additional Branch Circuit outlet information.

4. To apply an operative action to all outlets in a selected group, select the corresponding checkbox and select one of the following values from the drop-down list adjacent to the group, then click **Save**.
 - **On**: Turn on the selected group of outlets.
 - **Off**: Turn off the selected group of outlets.
 - **Reboot**: Reboot the selected group of outlets.
5. To modify ePDU threshold values for a specified group, click the link on the group friendly name. The Group Settings dialog displays.
6. **Administrator or User with Read/Write privileges only.** To specify the duration outlets in this group will be Off before switching On during a reboot, type the number of seconds the outlets should be Off in the Power Reboot Period text box. Click **Save**.

**NOTE**

This setting overwrites the Power Reboot Period defined for individual outlets on the Outlet Settings dialog.

7. To enter new threshold values, type new values in any of the text boxes that follow, then click **Save**:
 - Low warning current threshold
 - High warning current threshold
 - High critical current threshold
 - Low critical voltage threshold
 - Low warning voltage threshold
 - High warning voltage threshold
 - High critical voltage threshold
8. To reset the threshold values to the default values, click **Default**, then click **Save**.
9. To reset a kilowatt hour (kWh) counter to zero, click **Reset kWh**, then click **Save**.

Outlets

NOTE

The display varies depending on the profile assigned to the user.



- Switch settings will not display for Metered Outlet (MO) or Metered Input (MI) ePDUs.
- Threshold settings will not display for Switched (SW) ePDUs.
- Only the name of the outlets can be changed for Metered Input (MI) ePDUs.

Review/Modify ePDU Outlets

NOTE

This option is only for Switched (SW) and Managed (MA) ePDUs. The On/Off/reboot/last-known -state is associated with the "Control" feature for Managed (MA) or Switched (SW) ePDUs.

1. Access the Web interface and log in.
2. Under Power Management, select Outlets. The Outlets page displays.
3. Review basic monitoring information for individual outlets.

4. Click the outlet name to display a dialog for renaming the outlet.
5. To apply an operative action for a selected outlet, select the corresponding checkbox and then select one of the following values from the drop-down list adjacent to the outlet, then click **Save**.
 - **On**: Turn on the outlet.
 - **Off**: Turn off the outlet.
 - **Reboot**: Reboot the outlet.
6. To modify ePDU threshold values for a specified outlet, click the link on the group friendly name. The Outlet Settings dialog displays.
7. To set whether an outlet state (On, Off, or Reboot) can be changed, check or uncheck the Enable Switching check box, then click **Save**.
 - **Disabled**: Uncheck the check box to disable the setting, which indicates that the outlet state cannot be changed.
 - **Enabled**: Check the check box to enable the setting, which indicates that the outlet state can be changed.
8. To set the state of the outlet with the ePDU is powered on, select one of the following values from the State on Device Startup drop-down list, then click **Save**:
 - **On**: The outlet is powered after a duration of time set in the Outlet Switch On After field.
 - **Off**: The outlet is not powered.
 - **Last Known State**: The outlet is powered on if it was On when the ePDU was powered Off. Otherwise, the outlet is not powered.
9. **Administrator or User with Read/Write/Control only**. To specify the duration an outlet will be Off before switching On during a reboot, type the number of seconds the outlet should be Off in the Power Reboot Period(s) text box. Click **Save**.

**NOTE**

This setting can be overwritten by the Power Reboot Period defined for groups of outlets on the Group Settings dialog.

10. To enter new threshold values, type new values in any of the text boxes that follow, then click **Save**:
 - Low warning current threshold
 - High warning current threshold
 - High critical current threshold
11. To reset the threshold values to the default values, click **Default**, then click **Save**.
12. To reset a kilowatt hour (kWh) counter to zero, click **Reset kWh**, then click **Save**.

Environment

Configure Environment Sensor Settings

1. Access the Web interface and log in.
2. Under Power Management, select Environment. The Environment page displays.

- In the Environment panel, review the present ePDU environment monitoring temperature and humidity data. Also review the status of installed dry contacts, open or closed.



NOTE The environmental monitoring data panel only displays data if the EMP is installed and configured in the system.

- To modify environment threshold values, or to receive alarms when dry contacts change state, click the **Settings** button. The Environment Settings dialog displays.



NOTE In the Environment Settings dialog, the measure column displays the present status or state of the dry contacts. This is a read-only column.

- To select default values for thresholds or dry contacts, click **Default**.
- To enter new threshold values, type new values in any of the text boxes that follow, then click **Save**:
 - Low critical humidity alarm threshold
 - Low warning humidity threshold
 - High warning humidity threshold
 - High critical humidity alarm threshold
 - Low critical temperature alarm threshold
 - Low warning temperature threshold
 - High warning temperature threshold
 - High critical temperature alarm threshold
- To choose if you are notified when a dry contact state changes (Open or Closed), select one of the settings from the drop-down list under Open or Closed for the specified contact, then click **Save**:
 - Informational**: No alarm is generated.
 - Alarm**: An alarm is generated when the specified dry contact is Open or Closed.
- To reset the threshold values to the default values, click **Default**, then click **Save**.
- To cancel this action and return to the Environment page, click **Cancel**.



NOTE To change the temperature scale to Celsius or Fahrenheit unit of measurement (°C or °F), see "Setting General System Settings" on page 113.

Active Alarms



NOTE When the Active Alarms menu item in the menu bar list is red and displays an exclamation mark icon, an alarm is active.

Review Active Alarms

- Access the Web interface and log in.
- Under Power Management, select Active Alarms. The Active Alarms page displays.

3. Ensure the ePDU operation button in the upper left corner is not collapsed. If so, expand it to see the list of alarms.
4. Review the alarm detection date/time, description, the threshold setting, and the value reading that triggered the alarm.

NOTE 1 The term “active alarms” indicates that the alarm is currently set. When an alarm is no longer active, it is removed from this page.



NOTE 2 The format of the date is set on the System Date & Time submenu (see “Date & Time” on page 116).

Logs

Clear the Event Log

1. Access the Web interface and log in.
2. Under Logs & Notifications, select Logs. The Logs page displays.
3. Click **Clear**.



NOTE Only a user with read-write access can clear the log. Click the arrow beside Type to sort the order of the columns, to apply filters to see the logs for a specific data type, or to sort all data in ascending or descending order.

Download the Event Log as a Comma Separated Value File

1. Access the Web interface and log in.
2. Under Logs & Notifications, select Logs. The Logs page displays.
3. Click **Save to File**. The File Download dialog displays.
4. Click **Save**. The Save As window displays.
5. From the **Save in** drop-down list, specify where the file should be downloaded.
6. Either accept the default file name (logevent.csv) or enter a new file name.
7. Click **Save**.

NOTE For daisy-chained ePDUs:



- ePDU type 00 indicates the Host ePDU [0] logs.
 - ePDU type 01 indicates the Device ePDU [1] logs.
 - ePDU type 02 indicates the Device ePDU [2] logs.
 - ePDU type 03 indicates the Device ePDU [3] logs.
-

Trap Notification

Define the Trap Receivers

1. Access the Web interface and log in.
2. Under Logs & Notifications, select Trap Notification. The Trap Notification page displays.
3. Click a linked Trap Receiver in the Name column to select the trap receiver to define.
4. Type the name to identify the trap receiver. This value is not used to send traps.

5. Choose one of the following protocols:
 - **Disable:** The trap receiver is disabled. (No trap is sent to this user and the **Test** button is deactivated.)
 - **SNMP v1:** Traps are sent over SNMPv1 protocol. (It must be compliant with the SNMP version defined in “Enable/Disable the SNMP Agent” on page 120.)
 - **SNMP v3:** Traps are sent over SNMPv3 protocol. (It must be compliant with the SNMP version defined in “Enable/Disable the SNMP Agent” on page 120.)
6. Type the trap receiver IPv4 / IPv6 address or its host name.
7. Type the trap community (public or private).
8. From the On Event drop down list, select one of the following trap sources:
 - **Disable:** The trap receiver is disabled and the **Test** button is deactivated.
 - **All Alarms:** The trap receiver is enabled.
9. Click **Save**. If desired, test the configuration (see “Test Trap”).
10. Click **Test**. (See the “Test Trap” section that follows for more information).

Test Trap



NOTE

To receive the test trap #53, the trap receiver must be configured with a protocol compliant with the one defined as the trap source (see “Enable/Disable the SNMP Agent” on page 120).

This action consists of sending a test trap (#53) to all configured and enabled trap receivers. To achieve this action, the following requirements must be met:

- The ePDU Network Management and Control (eNMC) module is running in Normal Operation mode.
- The ePDU Network Management and Control (eNMC) module is connected to the Local Area Network (LAN).
- The ePDU Network Management and Control (eNMC) module owns a valid IP address.
- The SNMP must be enabled: SNMPv1, SNMPv3, or SNMPv1&v3.

The target trap receiver configuration requires a valid IP address and the trap receiver protocol must match the configured SNMP version.



NOTE

See “Enable/Disable the SNMP Agent” on page 120.

Syslog

Retrieve or Modify Syslog Data

1. Access the Web interface and log in.
2. Under Logs & Notifications, select Syslog. The Syslog Server page displays.
3. Review to the Syslog status, the port number, and the protocol for the specified Syslog server.
4. To enable or disable a server, click the check box beside the Syslog server name and click the **Enable** or **Disable** button.
5. To modify the settings for a server, click the Syslog name. The Syslog Server Settings dialog displays.

6. In the Syslog Server Settings dialog, enable or disable the selected server from the Enable Server drop-down list. You can also change the following:
 - the port number and the protocol selection to either UDP or TCP from the Protocol drop-down list
 - the message transfer method according to:
 - 5424: Syslog Protocol IETF
 - 5425: TLS
 - 5426: Transfer over UDP
 - 6587: Transfer over TCP
 - 3167: Syslog protocol IETF (obsolete)
 - the facility code used for all messages from 1 to 23
 - the use of unicode byte order mask (BOM) according to RFC 5424
7. When you finish modifying Syslog server settings, click **Save** or **Cancel**.
8. (Optional). Click **Test** to test the configuration.

Access Accounts

Configure the SuperUser

1. Access the Web interface and log in.
2. Under Settings, select Access Accounts. The Access Accounts page displays.
3. In the Admin Access panel, perform the following:
 - Type the SuperUser login.
 - Type the SuperUser password.
 - Type the SuperUser password again.
4. Click **Save**.

Configure the E-mail Notification Settings



NOTE 1 By default, an e-mail address is attached to each account.

NOTE 2 Any user can change his own e-mail address.

1. Access the Web interface and log in.
2. Under Settings, select Access Accounts. The Access Accounts page displays.
3. In the Admin Access panel, click the e-mail address link.
4. The e-mail recipient address displays. If needed, change the address.
5. If needed, type the descriptive text to identify the e-mail receiver.
6. Enable or disable the e-mail receiver in the status drop-down list.
7. Check the Attached Files check box to attach the event log file to the e-mail sent to this receiver, or uncheck the box to send the e-mail without the event log file.
8. Select the date of the next report using the date picker or manually enter the date in mm/dd/yyyy format.
9. Set the frequency of the report if this recipient should receive regular reports.

10. Set the time of delivery using the drop-down list.
11. Click **Test** to send a test e-mail.
12. Otherwise, click **Save** or **Cancel**.

Configure the LCD Password



NOTE 1 Only an administrator can activate, deactivate, or modify the LCD password.

NOTE 2 There can only be one LCD password on the ePDU.

1. Access the Web interface and log in.
2. Under Settings, select Access Accounts. The Access Accounts page displays.
3. In the LCD Access panel, perform the following:
 - Activate the feature to change the password.
 - Type the LCD password.
 - Type the LCD password again.
4. Click **Save**.

Configure Local User Access

NOTE 1 Only an administrator can create or modify a user account.



NOTE 2 Local users can use this user name and password for authentication if the authentication mode selected in the Network Security Global submenu is Local (see "Set Authentication Mode" on page 122).

NOTE 3 The User name is used for authentication. It must be unique. If there is a name conflict when you are creating a new account, a warning message displays.

1. Access the Web interface and log in.
2. Under Settings, select Access Accounts. The Access Accounts page displays.
3. In the Multi-User Access panel, select **Add a local user** from the Add drop down list. The Users Settings dialog displays.
4. Perform the following:
 - Type the user's login user name to replace the default name.
 - Type the user's password (minimum of five characters).
 - Type the user's password again.
5. Choose one of the following profile characteristics:
 - **Admin:** This user has administrator privileges and controls the access of other users to the Web interface. The Administrator can restart the communications module, but cannot perform a firmware upgrade.
 - **ePDU User:** This user has access to the ePDU and either read only or restricted read-write privileges.
 - **Outlet User:** This user has access to the specified outlet or outlets. Select the outlet or outlets and the user-defined groups this user can access.

6. Choose one of the following security levels:
 - **No Access:** The user is not allowed to access the Web interface.
 - **Read-Only:** The user can access the Web interface, view the measures, and view the thresholds of the outlets and groups. This user is not allowed to change any settings or perform actions.
 - **Read/Write:** The user can access the Web interface, view the measures, and is allowed to change settings.
7. To configure an e-mail address for this account, click the link of the e-mail address corresponding to this user. See “Configure the E-mail Notification Settings” for more information.
8. Click **Save**.
9. To enable an e-mail address for this account, click the link on the e-mail address under the e-mail Address column.

Configure Remote Group Access



NOTE 1 A remote account is an account that will be created on the communications module in order to be attached to LDAP users so they can use the ePDU. The account should already exist on the LDAP database.

NOTE 2 These LDAP users will use their LDAP login/password for authentication on the module.

1. Under Settings, select Access Accounts. The Access Accounts page displays.
2. In the Multi-User Access panel, select **Add a remote group** from the Add drop down list. The Remote Group Settings dialog displays.
3. Type the remote group login user name to replace the default name.



IMPORTANT

This login user name must match the group name that the user has in the LDAP database.

4. Choose one of the following profile characteristics:
 - **Admin:** This remote group has administrator privileges and controls the access of other users to the Web interface.
 - **ePDU User:** The administrator assigns this remote group either read only or read-write privileges to this user.
 - **Outlet User:** This user has access to the specified outlet or outlets. Select the outlet or outlets and the user-defined groups this user can access.
5. Choose one of the following security levels:
 - **No Access:** The user is not allowed to access the Web interface.
 - **Read-Only:** The remote group can access the Web interface, view the measures, and view the thresholds of the outlets and groups. This user is not allowed to change any settings or perform actions.
 - **Read/Write:** The remote group can access the Web interface, view the measures, and is allowed to change settings.
6. To configure an e-mail address for this account, click the link of the e-mail address corresponding to this user. See “Configure the E-mail Notification Settings” for more information.
7. Click **Save**.

8. To enable an e-mail address for this account, click the link on the e-mail address under the e-mail Address column.

User-Defined Group Definition



NOTE Only the Administrator has access to this page.

NOTE 1 Some monitoring data do not display for the Switched ePDU user-defined groups. This includes Current, Percent load, Apparent Power, Active Power, and kWh.



NOTE 2 You cannot change the state (On, Off, or Reboot) of a group of outlets using the Web interface for Metered Outlet (MO) ePDUs.

NOTE 3 The user-defined group feature is not available for Metered Input (MI) ePDUs because there are no measurements or controls on the outlets on that model.

Configure an Outlet for a User-Defined Outlet Group

1. Access the Web interface and log in.
 2. Under Settings, select Group Definition. The Group Definition page displays.
 3. Select one group from the list of groups. (The default is Group x, where x is the outlet number.)
 4. Either accept the default name in the Name text box or type a new name to identify the new group.
 5. Select **Enable** from the drop-down list. (Groups with disabled status are not visible in the ePDU Group menu.)
 6. To assign outlets to this group, select the name of the outlets from the Factory Groups, User-Defined Groups, or Outlets panel and click the right arrow. The outlets move to the Selected Outlets panel.
 7. Click **Save**.
 8. To ensure that you have configured the outlet groups correctly, select the ePDU Group from menu bar in the to view the groups list.
-



NOTE Up to 12 groups can be configured. One outlet can only be part of one user-defined group. You cannot create an empty group.

System

NOTE The Web interface will not be available as follows:



- during firmware upgrades using the **Upgrade network management card** button
 - during a communications module restart using the **Restart network management card** button
 - during restoration to factory defaults using the **Restore factory to default settings** button
-

Setting General System Settings



NOTE Refresh the Web pages (press F5) to see changes to the general system settings.

1. Access the Web interface and log in.
2. Under Settings, select System. The System Settings page displays.
3. In the General panel, type the Device Administrator Contact Name and the Device location in the text boxes.
4. To change the language, select a language from the drop down list (see Figure 75).

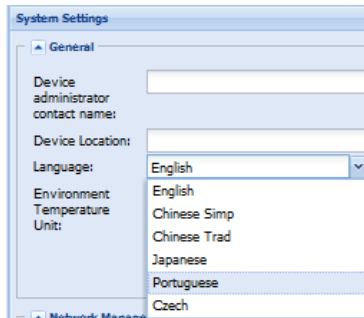

Figure 75. Change Language on System Settings Page

5. Select °C or °F in the Temperature drop-down list to change the temperature scale (Celsius or Fahrenheit unit of measurement).
6. Click **Save**.

Enable/Disable Firmware Upgrade

1. Access the Web interface and log in.
2. Under Settings, select System. The System Settings page displays.
3. In the Network Management Card panel, choose whether the firmware upgrade functionality can be used:
 - **Enabled:** Check the check box to use the firmware upgrade functionality (default).
 - **Disabled:** Uncheck the check box to disable the firmware upgrade functionality.
4. To save your changes, click **Yes** in response to the message prompt.

Communications Card Configuration

1. Access the Web interface and log in.
2. Under Settings, select System. The System Settings page displays.
3. In the Network Management Card Configuration panel, choose whether the IP setting and/or Daisy Chain settings should remain unchanged after a default factory reset of the eNMC module.
 - **Enabled:** Check the check box beside the Keep IP parameters when “Restore Factory Default Settings” to retain IP settings at their current values after restoration. Check the check box beside the Keep Daisy Chain parameters when “Restore Factory Default Settings” to retain IP settings at their current values after restoration.
 - **Disabled:** Uncheck the check box to reset IP settings (or Daisy Chain settings) to default values (default).

- To select and store an eNMC module configuration file to be used during an upgrade, use **Browse** to review and select the configuration file.



NOTE When uploading a file, you cannot write the file path in the text field. You must select the file from the file explorer window that displays when you click **Browse**.

- Click either **Upload** or **Download Configuration** and a message is provided to tell you if the file uploaded successfully or failed to upload:
 - Upload:** Gets the list of the ePDU XML parameters from a file selected by the browser and sends it to the ePDU.
 - Download Configuration:** Stores a list of the ePDU XML parameters in a file selected by the browser.
- To restore the eNMC module to factory defaults, click **Restore Factory to default settings**. A pop-up confirmation message displays:
 Are you sure you want to restore the factory default settings of the Network Management Card?
 Note: This will NOT restart the ePDU or change the power status of the outlets.

Perform Firmware Upgrade



NOTE A firmware upgrade can only be performed by a SuperUser. This upgrades the firmware and the Web page. The Web interface will not be available during the upgrade.

- Access the Web interface and log in.
- Under Settings, select System. The System Settings page displays.
- In the Network Management Card panel, ensure the firmware upgrade functionality is enabled and that the upgrade file has been downloaded.
- To upgrade the communications module, click **Upgrade network management card**. The upgrade is launched immediately.
- Click **Restart network management card**.
- When the upload of the image file completes, the following message displays:
 Your file was correctly uploaded.
 Please wait about three minutes while the image writes to your flash device,
 then click the browser refresh button.
 Click OK to restart the card and begin the upgrade of the firmware.

ePDU Configuration

- Access the Web interface and log in.
- Under Settings, select System. The System Settings page displays.
- Ensure that the Device Administrator Contact Name and the Device location have been typed in the text boxes.

- To select and store an eNMC module configuration file to be used during an upgrade, use **Browse** to review and select the configuration file.



NOTE When uploading a file, you cannot write the file path in the text field. You must select the file from the file explorer window that displays when you click **Browse**.

- Click either **Upload** or **Download Configuration** and a message is provided to tell you if the file uploaded successfully or failed to upload:
 - Upload:** Gets the list of the ePDU XML parameters from a file selected by the browser and sends it to the ePDU.
 - Download Configuration:** Stores a list of the ePDU XML parameters in a file selected by the browser..
-



NOTE The file to upload must be a file compatible with the hardware of the ePDU. If not, the upload does not process due to an incompatibility error.

Date & Time

Manually Configure the Date and Time

- Access the Web interface and log in.
- Under Settings, select Date & Time. The Date & Time page displays.
- In the Global Settings panel, choose the date format from the drop-down list.
- Click **Save**.
- Click the **Set manually** radio button.
- Type the date according to the format defined by Date Format, or select the date using the date picker.
- Type the time or select a time from the drop-down list. The time format is *hh:mm:ss*, where *hh* = hours, *mm* = minutes, *ss* = second.
- Click **Save**.

Automatically Configure the Date and Time

- Access the Web interface and log in.
 - Under Settings, select Date & Time. The Date & Time page displays.
 - In the Global Settings panel, choose the date format.
 - Click **Save**.
 - In the Global Settings panel, click the **Synchronize with NTP Server** radio button
 - Type the Time Server IPv4 / IPv6 address or host name.
 - Choose the time zone from the drop-down list.
 - If desired, check the Daylight Saving Time option.
 - Click **Save**.
-



NOTE The ePDU Network Management and Control (eNMC) module retrieves the date and time from the configured NTP server every hour.

TCP/IP



NOTE The Web interface will not be available during a communications module restart using the **Restart network management card** button.

Configure the Ethernet Link Speed and Duplex Mode

NOTE By default, the Ethernet link speed and duplex mode is configured on “auto-negotiation” which means the eNMC module adapts its Ethernet speed and duplex mode to the network on which it is connected. However, it is possible to force the following modes:



- Auto-negotiation
- 100 Mbps Full Duplex
- 100 Mbps Half Duplex
- 10 Mbps Full Duplex
- 10 Mbps Half Duplex

-
1. Access the Web interface and log in.
 2. Under Network, select TCP/IP. The TCP/IP page displays.
 3. In the Ethernet panel, choose one of the following link speed and duplex modes from the drop-down list:
 - Auto-negotiation
 - 100 Mbps Full Duplex
 - 10 Mbps Half Duplex
 - 10 Mbps Full Duplex
 - 10 Mbps Half Duplex
 4. Click **Save**.
 5. Open the System page. In the Network Management Card panel, click **Restart network management card** to restart the ePDU Network Management and Control (eNMC) module. A pop-up confirmation message displays:

Are you sure you want to restart the Network Management Card?
Note: This will NOT restart the ePDU or change the power status of the outlets.

Configure the IPv4 Settings

1. Access the Web interface and log in.
2. Under Network, select TCP/IP. The TCP/IP page displays.
3. In the IPv4 panel, select the manner by which IPv4 settings are configured from the BootP/DHCP drop-down list:
 - **Enabled.** The IPv4 settings are configured by the DHCP server. If DHCP is enabled, go to Step 5.
 - **Disabled.** The IPv4 settings are manually configured by the user. If DHCP is disabled, perform the following:
 - Type the IPv4 address.
 - Type the IPv4 subnet mask.
 - Type the IPv4 address of the gateway (if any).
 - Type the ePDU host name (used for DNS resolution).
 - Type the ePDU domain name (used for DNS resolution)
4. Click **Save**.
5. Open the System page. In the Network Management Card panel, click **Restart network management card** to restart the ePDU Network Management and Control (eNMC) module. A pop-up confirmation message displays:

Are you sure you want to restart the Network Management Card?

Note: This will NOT restart the ePDU or change the power status of the outlets.

Configure the IPv6 Settings



NOTE By default, the IPv6 interface is disabled. You can enable it from the Web interface or the Serial interface.

1. Access the Web interface and log in.
2. Under Network, select TCP/IP. The TCP/IP page displays.
3. In the IPv6 panel, enable the IPv6 interface by checking the **IPv6 Enabled** check box.
4. Select one of the following configuration methods for IPv6 settings
 - For manual configuration, uncheck the **IPv6 Address Auto Configuration Enabled** check box. Continue to Step 5.
 - For auto configuration, check the **IPv6 Address Auto Configuration Enabled** check box. Continue to Step 10.

NOTE 1 For manual configuration, provide the IPv6 global address with its prefix length and the IPv6 address of the gateway (if any).



NOTE 2 For auto-configuration, the global IPv6 addresses and prefix lengths are automatically configured by the network (an IPv6 router is required). The gateway IPv6 address is defined by the user.

NOTE 3 Regardless of the configuration you choose, the local IPv6 address is auto-generated by the eNMC module.

5. Type the local IPv6 address.
6. Type the prefix length for the global IPv6 address.

7. Type the IPv6 gateway address (if any).
8. Type the second IPv6 address and prefix.
9. Click **Save**.
10. Open the System page. In the Network Management Card panel, click **Restart network management card** to restart the eNMC module. A pop-up confirmation message displays:
Are you sure you want to restart the Network Management Card?
Note: This will NOT restart the ePDU or change the power status of the outlets.

Configure the DNS

When the IPv4 address is automatically obtained by DHCP, the DNS server addresses (primary and secondary) are provided by the DHCP server.

You can define DNS IPv4/IPv6 addresses from the Web and Serial interfaces. However, this configuration is overwritten when the ePDU Network Management and Control (eNMC) module restarts and the IPv4 address is obtained from a DHCP server that provides DNS addresses.

1. Access the Web interface and log in.
2. Under Network, select TCP/IP. The TCP/IP page displays.
3. In the DNS panel, type the primary DNS server's IPv4 or IPv6 address.
4. Type the secondary DNS server's IPv4 or IPv6 address (if any).
5. Click **Save**.

Configure the SMTP

1. Access the Web interface and log in.
2. Under Network, select TCP/IP. The TCP/IP page displays.
3. In the SMTP panel, type the SMTP server IPv4 / IPv6 address or host name.
4. If not already provided, type the SMTP port.
5. If your SMTP server requires authentication, perform the following:
 - Check the SMTP Server Authentication check box.
 - Type the login.
 - Type the password.
 - If not already provided, type the sender address.
6. Click **Save**.

SNMP

Enable/Disable the SNMP Agent

1. Access the Web interface and log in.
2. Under Network, select SNMP. The SNMP Settings page displays.
3. Choose one of the following SNMP versions:
 - **Disabled:** the agent is disabled; the MIB cannot be read and no traps are sent.
 - **SNMPv1:** only SNMPv1 users and SNMPv1 traps are supported.
 - **SNMPv3:** only SNMPv3 users and SNMPv3 traps are supported.
 - **SNMPv1 & v3:** both SNMPv1 and SNMPv3 users and traps are supported.
4. Type the SNMP Port number and the SNMP Trap Port number in the entry boxes.
5. Click **Save**.

Define SNMPv1 Users

1. Access the Web interface and log in.
2. Under Network, select SNMP. The SNMP Settings page displays.
3. Ensure that SNMPv1 is selected in the SNMP Version field.
4. In the SNMP V1 panel, in the Community column, select the SNMPv1 user to configure. The Community Settings dialog displays.
5. Choose one of the following access rights for the selected SNMPv1 user:
 - **No Access:** The user is not allowed to access the Web interface.
 - **Read-Only:** the SNMPv1 user can only get the MIB objects.
 - **Read-Write:** the SNMPv1 user can get and set the MIB objects.
6. Click **Save**. Otherwise, click **Cancel** to return to the SNMP Settings page.

Define SNMPv3 User-based Security Model Users

1. Access the Web interface and log in.
2. Under Network, select SNMP. The SNMP Settings page displays.
3. Ensure that SNMPv1 is selected in In the SNMP Version field.
4. In the SNMP V3 panel, in the Users column, select the SNMPv3 user to configure. The SNMP User Settings dialog displays.
5. Choose one of the following access rights for the SNMPv3 user:
 - **No Access:** the SNMPv3 user is disabled with no access to the MIB objects.
 - **Read-Only:** the SNMPv3 user can only get the MIB objects.
 - **Read-Write:** the SNMPv3 user can get and set the MIB objects.

6. Choose one of the following security levels to be applied to the SNMPv3 user:
 - **Not Set**: the SNMPv3 user is not configured and therefore disabled.
 - **Auth Priv**: an authentication password and a privacy key are required to access the MIB objects.
 - **Auth No Priv**: an authentication password but no privacy key are required to access the MIB objects.
 - **No Auth No Priv**: no authentication password or privacy key are required to access the MIB objects.
7. Type the authentication password (if required by security level), with 8 to 24 characters allowed.
8. Type the privacy key (if required by security level), with 8 to 24 characters allowed.
9. Click **Save**. Otherwise, click **Cancel** to return to the SNMP Settings page.

Access Eaton ePDU MIB Objects (Privileged Access Only)

1. Access the Web interface and log in.
2. Under Network, select SNMP. The SNMP Settings page displays.
3. Click **Link to the ePDU Mib**.

Security

Enable/Disable SSL Encryption

1. Access the Web interface and log in.
2. Under Network and Security, select Global. The Security page displays.
3. In the Ports Settings panel, ensure that the **HTTP Enable** check box is checked and that the associated HTTP Port number displays.
4. Check the **Force SSL** check box to enable SSL encryption, or uncheck the box to disable it. If enabled, the HTTPS Port entry box is active. Type the port number.
5. Click **Save**.
6. Open the System submenu in the Settings menu. In the Network Management Card panel, click **Restart network management card** to restart the ePDU Network Management and Control (eNMC) module.



NOTE With SSL encryption, the Web interface is accessible from **https://<IPv4 address>** and / or **https://[IPv6 address]** according to the IP configuration.



NOTE When **Force SSL** is selected, the Web page is only available through HTTPS. If you enter the IP address through HTTP, it will be automatically redirected to HTTPS and you will receive the following message and a new URL link:
 The Network Management Card is protected by SSL encryption.
 Please use the following address(es) to connect to the Network Management Card. **https://166.99.224.82**

Enable/Disable the Telnet Interface

**NOTE**

Selecting a console type on the Security page makes the corresponding port entry box active.
Not selecting a console type makes the corresponding port entry box inactive and grayed-out.

1. Access the Web interface and log in.
2. Under Network and Security, select Global. The Security page displays.
3. In the Ports Settings panel, select **Telnet** from the Console drop-down list to enable the Telnet interface, or select **Disabled** to disable it.
4. If enabled, the Telnet Port entry box is active. Type the port number.
5. Click **Save**.
6. Open the System submenu in the Settings menu. In the Network Management Card panel, click **Restart network management card** to restart the ePDU Network Management and Control (eNMC) module.

Enable/Disable the SSH Interface

1. Access the Web interface and log in.
2. Under Network and Security, select Global. The Security page displays.
3. In the Ports Settings panel, select **SSH** from the Console drop-down list to enable the SSH interface, or select **Disabled** to disable it.
4. If enabled, the SSH Port entry box is active. Type the port number.
5. Click **Save**.
6. Open the System submenu in the Settings menu. In the Network Management Card panel, click **Restart network management card** to restart the ePDU Network Management and Control (eNMC) module.

Enable/Disable FTP

1. Access the Web interface and log in.
2. Under Network and Security, select Global. The Security page displays.
3. In the Ports Settings panel, check the **FTP Enable** check box to enable FTP, or uncheck the box to disable it.
4. Click **Save**.
5. Open the System submenu in the Settings menu. In the Network Management Card panel, click **Restart network management card** to restart the ePDU Network Management and Control (eNMC) module.

Set Authentication Mode

1. Access the Web interface and log in.
2. Under Network and Security, select Global. The Security page displays.

3. In the Authentication Mode panel, select a value from the External Authentication drop-down list:
 - **None:** This disables external authentication. The Preference Order field is automatically checked to the **Local First, then External** value.
 - **Radius:** This enables RADIUS. If LDAP or RADIUS are enabled, you must set a preference order in the Preference Order drop-down list:
 - **External First, then Local**
 - **Local First, then External**
 - **External only**
 - **LDAP:** This enables LDAP. If enabled, you must set a preference order in the Preference Order drop-down list:
 - **External First, then Local**
 - **Local First, then External**
 - **External only**
4. Click **Save**.
5. Open the System submenu in the Settings menu. In the Network Management Card panel, click **Restart network management card** to restart the eNMC module.

Set LDAP Search Configuration

NOTE Each selection combination requires a different set of entries. Only applicable fields are active. Fields that do not apply to your selection are inactive.



- Active fields are white and the inactive fields are blue shaded.
 - When you click your cursor in inactive fields, nothing happens.
 - You can type in active fields.
-

1. Access the Web interface and log in.
2. Under Network and Security, select LDAP. The LDAP page displays.

3. Select the LDAP Server Type, User Search Bind, and Authorization Mode values from the drop-down list:
 - **LDAP Server Type:** Allows you to select a configuration.
 - **Active Directory:** Allows to configure a typical AD configuration. Some fields are read-only (User Object and User Attribute are disabled).
 - **Other:** All fields are editable.
 - **User Search Bind:** Defines if a special user for the LDAP searches must be used.
 - **Anonymous Search:** Search bind uses an anonymous way (Search User and Password are disabled)
 - **User bind Search:** Uses an LDAP user.
 - **Search User:** DN (if Bind Type = simple) or the username (if Bind Type = MD5) of the LDAP user allowed to search in the LDAP dictionary.
 - **Password:** Password of the Search User.
 - **User Base DN:** Entry of the LDAP dictionary where to start the user search.
 - **User Object:** Object class of the LDAP users.
 - **User Attribute:** Login identifier.
 - **Authorization Mode:** Choose authorization by user attribute or by group.
 - **By User attribute:** Stores the group name in the user attribute (Group Name Attribute).
 - **By Group:** Stores the group name in the group LDAP object (UPS Group Base DN).
 - **UPS Group Base DN:** LDAP dictionary entry from which the group search starts.
 - **Group Name Attribute:** LDAP attribute that stores the group name.
 - **User Name Attribute:** LDAP attribute that stores the users names linked to this group.
4. The resulting required field entries are active and highlighted. Type the associated values in the active entry boxes.
5. Click **Save**.

Set LDAP Server Global Parameters

1. Access the Web interface and log in.
2. Under Network and Security, select LDAP. The LDAP page displays.

3. In the LDAP Server Global Parameters panel, select the following:
 - **Encryption Method:** The Encryption method defines if an SSL connection is used between the ePDU and the LDAP server when the LDAP requests are sent during the ePDU user authentication process. From the drop-down list, select one of the following:
 - **None:** (No SSL connection) The data is sent without encryption. The standard port number is 389 (the port for no encryption). It can be set or modified from the LDAP Server Settings dialog.
 - **LDAPS:** (With SSL Connection) This selection uses an LDAP-over-SSL connection. The standard port number is 636. It can be set or modified from the LDAP Server Settings dialog
 - **Start TLS:** (With SSL Connection) Use the "start TLS" extension (RFC 2830). The standard port number is 389 (the same port that for no encryption). It can be set or modify from the LDAP Server Settings dialog.
 - **Bind Type:** The bind operation uses the LDAP user credentials to identify the LDAP authentication connection between the ePDU and the LDAP server. From the drop-down list, select one of the following:
 - **Simple:** The user credentials are sent without encryption. However, if an SSL connection is used, the credentials are encapsulated in an SSL-encrypted connection.
 - **SASL Digest MD5:** Using MD5, a hash algorithm is used to encrypt the user credentials.
4. To upload your AC Certificate, select **Browse**. Highlight the selected file and click **Open**.



IMPORTANT

The AC Certificate is the AC Certificate of the LDAP server, not the AC Certificate of the ePDU. The certificate format is a Base64 encoded DER certificate, enclosed between the "-----BEGIN CERTIFICATE-----" and "-----END CERTIFICATE-----" tag. In order to configure your LDAP server for SSL, you need the AC certificate of the ePDU certificate.



NOTE

When uploading a file, you cannot write the file path in the text field. You must select the file from the file explorer window that displays when you click **Browse**.

5. Click **Upload**.
6. Click **Save**.

Modify LDAP Server Settings

1. Access the Web interface and log in.
2. Under Network and Security, select LDAP. The LDAP page displays.
3. In the LDAP Server panel, click a linked host name. The LDAP Server Settings dialog displays.
4. In the Enable Server drop-down list, select **Enable** or **Disable** to enable or disable the selected LDAP server or servers.
5. If enabled, you can choose to change the server name, the port number, and the number of seconds to time out in the Server, Port, and Time Out (sec) entry boxes.
6. Click **Save**. Otherwise, click **Cancel** to return to the LDAP page.

Add RADIUS Server

Authorization configuration must be done in the radius server to add the ePDU remote group defined in the Remote Group Access ePDU setting.

The authorization is based on the information sent by the server through the following RADIUS attribute:

- Vendor Specific ID: 534
- Vendor Specific Attribute ID: 29, format string

The authorization strings sent by the server from the vendor-specific attributes (VSA) are compared with the remote groups configured in the ePDU. If a remote group is found, the profile user linked to the remote group is set to the remote user (in case of authentication success). If no group is found, the access is rejected by the ePDU.

This attribute must be added in the RADIUS server configuration and must be sent for each remote user allowed to access to the ePDU.

To add a RADIUS server:

1. Access the Web interface and log in.
2. Under Network and Security, select RADIUS. The RADIUS page displays.
3. In the RADIUS Server panel, select the following:
 - **Authentication Protocol:** Select an authentication method from the drop down list, either Password Authentication Protocol (PAP) or Challenge-Handshake Authentication Protocol (CHAP).
4. Check the **Add** check box.
5. In the RADIUS Settings panel, select the following:
 - **Primary or Secondary Server:** Identify the server by selecting Primary Server or Secondary Server.
 - **Enable Server:** From the drop-down list, select **Enable** to enable the server or **Disable** to disable the server.
 - **RADIUS Server:** Enter the IPv4 address, IPv6 address, or the host name of the RADIUS server.
 - **Secret:** Shared secret (case sensitive).
 - **NAS IP Address:** The NAS field allows you to select an IP address from the IP addresses of the card.
 - **UDP Port:** The User Datagram Port (UDP) number (standard: 1812).
 - **Time Out (sec):** Type the number of seconds to wait for a response from the authentication server before trying to reconnect.
 - **Retry Number:** Type the number of times to try to reconnect to the authentication server before reporting that the connection failed for one authentication attempt.
6. When you finish selecting parameters for the RADIUS server, click **Save** or **Cancel**.

Edit Parameters for a RADIUS Server

1. Access the Web interface and log in.
2. Under Network and Security, select RADIUS. The Security - RADIUS page displays.
3. In the RADIUS Server panel Name column, click the name of the RADIUS server you want to edit.
4. The RADIUS Settings dialog displays. Change the parameters as needed.
5. When you finish modifying parameters for the RADIUS server, click **Save** or **Cancel**.

Chapter 9 Maintenance and Alarms

This section explains maintenance functions for the Eaton Enclosure Power Distribution Unit (ePDU) G3, including:

- Preventive maintenance
- Equipment disposal
- Replacing the ePDU Network Management and Control (eNMC) module
- Updating Firmware
- Alarms

Preventive Maintenance

For the best preventive maintenance, keep the area around the ePDU clean and dust-free. If the atmosphere is very dusty, clean the outside of the system with a vacuum cleaner. Do not to exceed 60°C (140°F) for best performance.

Equipment Disposal

Contact your local recycling or hazardous waste center for information on proper disposal of the used ePDU.



CAUTION

Do not discard waste electrical or electronic equipment (WEEE) in the trash. For proper disposal, contact your local recycling/reuse or hazardous waste center.

Replacing the ePDU Network Management and Control Module



NOTE Handle the eNMC module with care. Be aware that there is a risk of electrostatic discharge (ESD). As a preventive measure, wear ESD protection, such as an ESD shoe strap, while replacing the eNMC module. Do not put stress on the connection cable during installation.

To replace the eNMC module (see Figure 76):

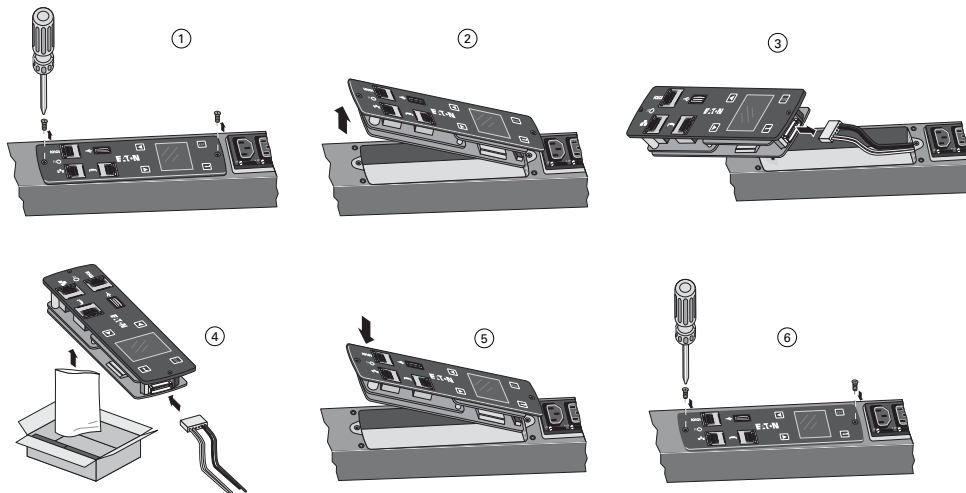

Figure 76. Replacement Procedure

1. Remove the two eNMC module mounting screws.
2. Tilt up one side of the eNMC module and locate the attached cable harness.
3. Disconnect the cable harness and remove the eNMC module.
4. Locate and unwrap the new eNMC module. Connect the cable harness to the new eNMC module.
5. Reinsert the new eNMC module.
6. Install the two eNMC module mounting screws.



NOTE After the new eNMC module is connected, the “internal communication error” message displays until the configuration file is uploaded to the eNMC module.

7. The new eNMC module will not have the same MAC address as the one you are replacing. Ensure the old MAC address label is discarded and that new MAC address label is firmly adhered to the product.
8. Download the hardware configuration file using one of the following processes:
 - From the Web (go to Step 9)
 - From the USB with an ePDU with the same configuration (go to Step 14)
9. Go to www.eaton.com/ePDU.
10. In the upper left corner of the page, click the Sign In button. If you are already logged in, the button will say “Sign Out” instead of “Sign In” (see Figure 77).

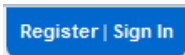



Figure 77. Sign In/Sign Out Button

11. After signing in, use the ePDU Part Number Search to find the webpage for the desired model. (The link to the configuration file only displays if you are signed in.)
12. Download the hardware configuration file to your computer using the link near the bottom of the page for your model. Be sure that the Configuration number on the unit rating label also appears in the file name of the hardware configuration file.
13. Go to Step 17.
14. Connect a USB flash drive to a working PDU of the same configuration as the one that has just had the eNMC replaced.
15. Using the LCD display, follow the procedure to “Save the eNMC Hardware Configuration File to the USB” on page 54.
16. Disconnect the USB device from the working ePDU.



NOTE To perform the eNMC configuration upload with USB, only one hardware configuration file must be stored in the USB key.

17. Upload the configuration file using one of the following processes:
 - FTP (Step 18)
 - USB (Step 28)

 **NOTE** For FTP operation, FTP must be enabled (default setting) in the Web pages (Network > Security > Global > FTP enable).

18. Open a DOS command window on a computer that is also connected to network.

19. Change directory (CD) to the location of the XML file.

20. Open an FTP session using the following command:

```
>ftp <IPAddress>
```

where <IPAddress> = the IP address displayed on LCD

21. Type the default login and password ("admin" and "admin").

22. At the command prompt, type the following command:

```
>cd config/hw
```

```
>dir
```

23. If an XML file already exists, type the following command to delete the XML file:

```
>delete <config file>
```

24. To upload the configuration file to the eNMC module, type the following command:

```
>put <config file>
```

where <config file> = the file name to be downloaded to the eNMC module

 **NOTE** Keep the <config file> name exactly as it is downloaded from the website. In particular, it must begin with the prefix "epdu_cfg_" or the eNMC module will not recognize it.

25. Type the following command and ensure that the new file exists:

```
>dir
```

26. Type the following command to quit the FTP session:

```
>quit
```

27. Go to "Reboot the eNMC Module and Reset the ePDU" on page 130.

28. Connect the USB device with the uploaded hardware configuration file to the ePDU that has just has the eNMC.

29. Using the LCD display, follow the procedure to "Load the eNMC Configuration File from the USB" on page 54.

30. Go to "Reboot the eNMC Module and Reset the ePDU" on page 130.

 **NOTE** To perform the eNMC configuration upload with USB, only one hardware configuration file must be stored in the USB key.

Reboot the eNMC Module and Reset the ePDU

1. Reboot the eNMC module using either the reset button on the LCD front panel or using a serial or network connection to a terminal emulator or Web interface.
2. Reset the ePDU to factory default settings using a serial or network connection to a terminal emulator, Web interface, or LCD menu.



NOTE Step 1 and Step 2 must be performed or the new configuration will not be properly accepted by the eNMC module. If something doesn't look right afterward, perform Step 2 (reset to defaults) a second time.

After the configuration file is uploaded and eNMC module is rebooted, the ePDU settings return to default settings and the energy counter restarts from 0. Only the serial number is recovered.

Firmware Upgrade

The firmware upgrade process allows you to maintain the most current firmware by updating the ePDU Network Management and Control (eNMC) module with new or enhanced features and applying periodic bug fixes.

The upgrade file is named **Image<xxx>.bin**. (The <xxx> values will vary for each upgrade.) During the upgrade, the firmware and the Web page are both upgraded to avoid incompatibility between the firmware version and the Web site. Additional validation checks are performed as well.

The new firmware files can be uploaded using either Hypertext Transfer Protocol (HTTP), File Transfer Protocol (FTP), or USB. With all methods, the basic steps are the same:

1. **Upload the Binary File.** This file will be stored in a temporary location in the communications module.
2. **Implement the Firmware.** After the file is loaded, the bootloader will implement the firmware in the eNMC module to upgrade the firmware and refresh the Web pages.



NOTE Groups of Eaton ePDU G3 models can be configured or updated with new firmware at the same time using Eaton Intelligent Power Manager (IPM). The IPM software is available separately at no cost for up to 10 devices. Refer to the *Eaton Intelligent Power Manager (IPM) User's Guide* for more information.



IMPORTANT

We strongly recommend that you leave only one IPM activated when mass upgrade or mass configuration operations are performed to upgrade eNMC from IPM. You should shut off all paralleled IPM (up to 9) during these operations.

Upgrading Firmware with Hypertext Transfer Protocol

The HTTP upgrade using the Web occurs in two stages:

- Upload the binary file
- Implement the firmware

Uploading the Binary File

To access the Web interface:

1. Ensure that an Ethernet cable is correctly connected between a Windows PC and the Ethernet port on the ePDU. Verify communication.
2. Start up the ePDU and note the IP address displayed on the LCD.
3. Open the Web browser and type the IP address you obtained from the ePDU.
4. When the connection is made, the Authentication dialog displays.
5. Enter a valid user name and password in the authentication dialog box (see Figure 78). Click **Login** to continue or **Cancel** to exit.



NOTE The default user name is “admin” and the default password is “admin.”

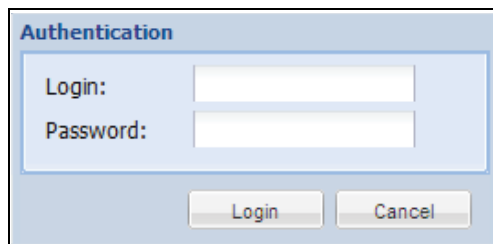

The image shows a web-based authentication dialog box titled "Authentication". It contains two input fields: "Login:" and "Password:". Below the input fields are two buttons: "Login" and "Cancel".

Figure 78. Login Authentication

6. The ePDU Overview page displays.
7. From the menu bar, click Settings and then System. The System Settings page displays in the Main Application window (see Figure 79).
8. In the Network Management Card panel, check **Firmware upgrade enabled** and click **Browse** to find the upgrade file.

Eaton ePDU G3 Metered Input Logout admin

System Settings

General

Device administrator contact name:

Device Location:

Language: English

Environment Temperature Unit: °C

Network Management Card

Firmware upgrade enabled

Choose an upgrade file for the Network Management Card

Network Management Card Configuration

Keep IP parameters when "Restore Factory Default Settings"

Choose a configuration file for the Network Management Card

ePDU Configuration

Choose a configuration file to upload

ePDU Information

Description	MI 0U L6-30P - (36) C13, (6) C19
Part Number	EMI4MT15JDG8-C1
Serial Number	U168D34004
F/W version	00.00.0a25
Web version	00.00.0a16
Bootloader version	00.00.0015
IPv4	10.130.33.222
IPv6	
Mac Address	00:20:85:F4:02:48
Time Up	6 hours 44 min 2 sec
Location	
Contact	
Contact Web Site	http://www.eaton.com/support/ePDU
Licenses	Click here

! Warning, some Alarms fired, please refer to the [Active Alarms](#) | Last Refresh: 20/02/1970 - 05:44:45

Figure 79. System Settings Page

9. From the Open window, select the **Image<xxx>.bin** file, and click **Open**.
10. In the Network Management Card panel, click **Upgrade Network Management Card** to launch the upload. A progress bar shows the progress of the update.

⚠ CAUTION

Do not disturb the upgrade until the progress bar shows complete.

11. When finished, a message displays and the communications module restarts automatically. The upgrade takes four to five minutes. When the upgrade completes, refresh the Web pages.

Upgrade the Firmware and Refresh Web Pages

After the binary file is uploaded to the communications module, the final step is an automatic process that upgrades the firmware and refreshes the Web pages.

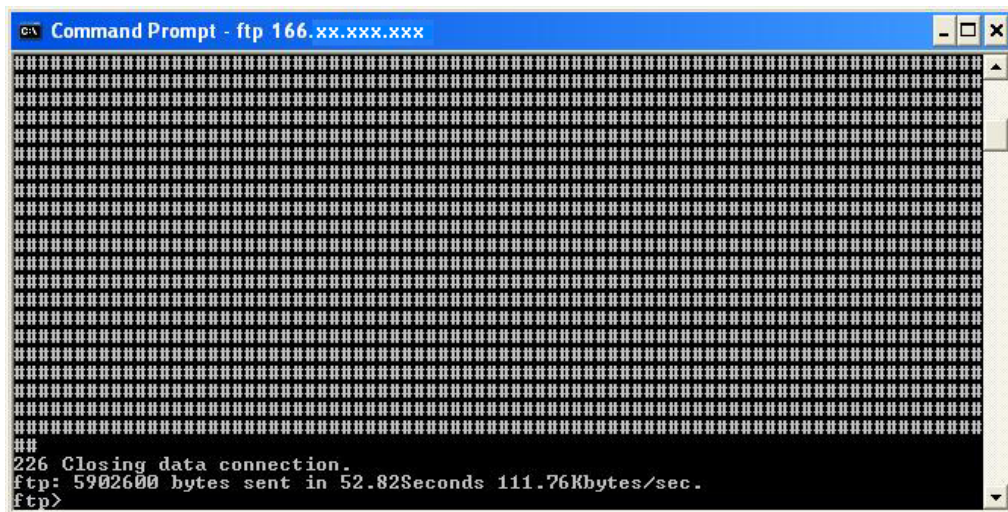

Figure 81. Closing Message

Upgrade the Firmware and Refresh Web Pages

After the binary file is uploaded to the communications module, the final step is an automatic process that upgrades the firmware and refreshes Web pages.

The communications module reboots and, in Bootloader mode, detects a new available image, checks validity of this image, and launches the upgrade of the firmware and refresh the Web pages. As the upgrade processes, the LCD display shows the completion status.

When completed, an upgrade message on the LCD displays **F/W: 100%**, and the communications module reboots with the new firmware and refreshed Web pages.

Upgrading the Firmware with the USB Port

See “Settings Menu” and “USB Flash Mode Submenu” on page 52 for more information of upgrading with the USB.

Active Alarms

The Eaton ePDUs have a rich set of alarms and events to notify you of up-to-date activity and operation status. Both the local ePDU LCD interface and the remote Web interface provide active alarm notifications when alarms become active.

- On the LCD interface, the existing LCD display is replaced by the Active Alarms screen and the backlight is blinking red when an alarm is generated.
- On the Web interface, two active alarm notifications are provided:
 - In the menu hierarchy, the text for Active Alarms is red when alarms are active.
 - In the bottom of the window (the refresh bar), a message displays, “Warning, some alarms fired, please refer to the Active Alarms | Last Refresh: dd/mm/yyyy - hh:hh:ss.” The words “Active Alarms” in the message are a link to the Active Alarms page.



NOTE The alarm and event list is subject to change.



NOTE For LCD interface information, see “Active Alarms Menu” on page 46. For Web interface information, see “Active Alarms” on page 107.

- To clear flashing LCDs and the LED:
 - Press any button on the ePDU or clear the alarm using the Web interface.
- To correct a condition:
 - Define the alarm condition and resolve the condition.
- Self-correcting conditions:
 - Sometimes, the alarm automatically clears when the condition resolves. For example, if a load over current alarm is generated, the alarm is cleared when the current drops 0.1A below the level (alarm hysteresis).

Defining the Alarm or Event Condition

You can derive defining information about the alarm or event from the associated number code. Figure 82 shows the location of the associated number code in the Code column on the Logs page of the Web interface.

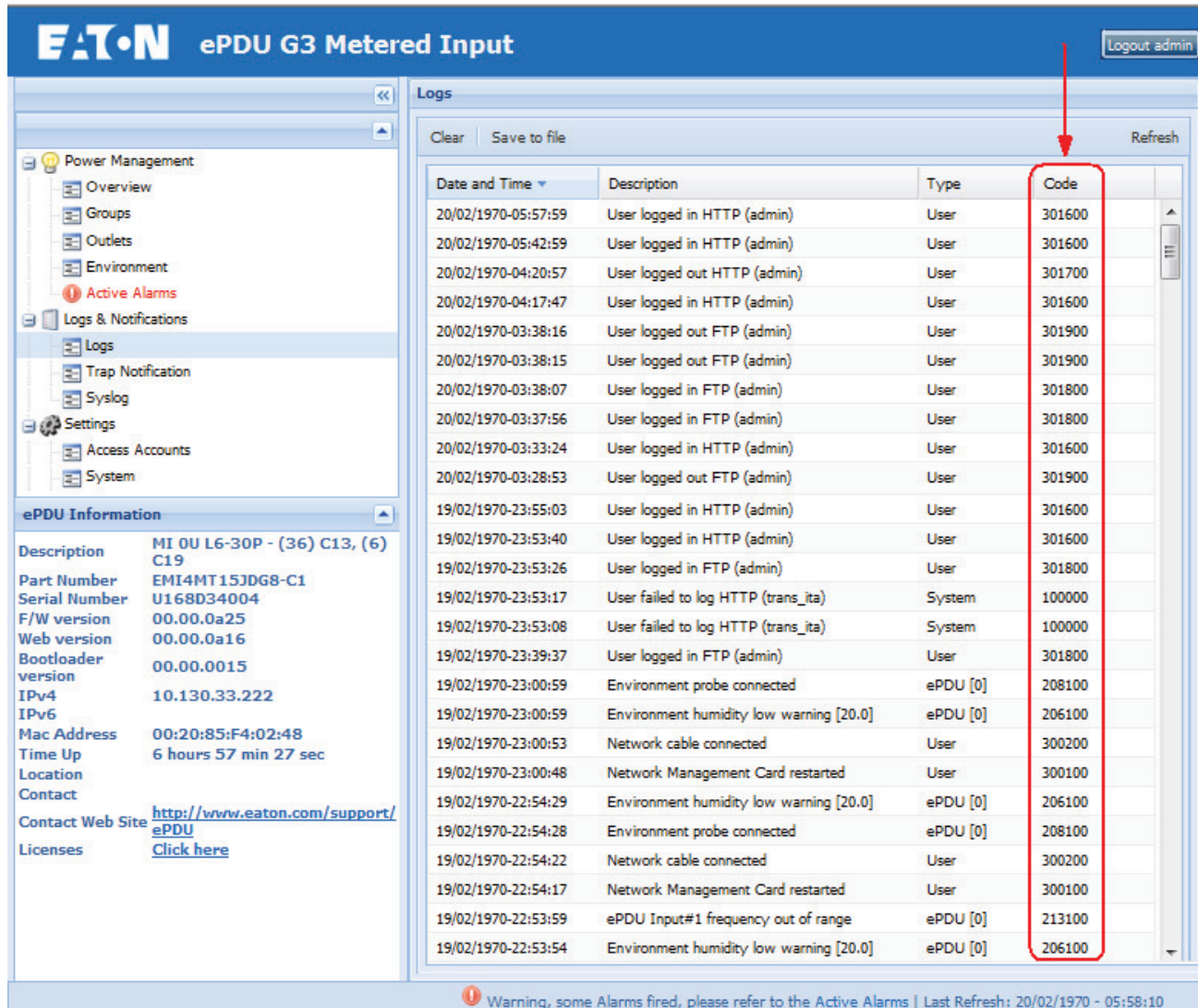

Figure 82. Location of Alarm Code on Web Interface

This number code is a six-digit number. The first digit in the number conveys the source of the alarm or event. The remaining five digits in the number code further identify and define the type of alarm (see Figure 83).

5-Digit Index Code and/or Identification Code:
 For Type 0 and Type 1 = Identification Code (0 to 9999)
 For Type 2 and Type 3 = Identification Code (0 to 999) and Index Code (0 to 99)

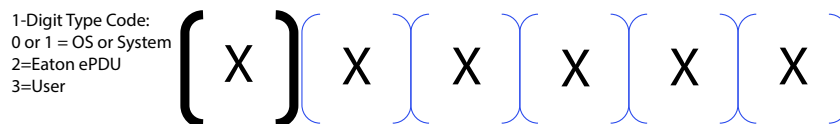

Figure 83. Alarm Code Format

Type Code 0 or 1 (OS or System)**IMPORTANT**

For Type Code 0 and Type Code 1, always contact customer support for assistance. These errors are not user-correctable.

The Type Code 0 and Type Code 1 alarms and events are triggered from the OS or the system. Figure 84 provides an example of a Type Code 1 system alarm number code. It only contains an 5-digit identification code (no index code).

Alarm number code 102820: No answer from a CAN device

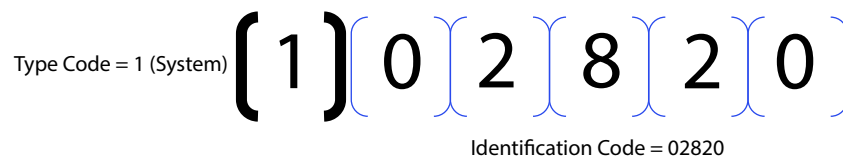

Figure 84. Example Type 1 Code

Table 11 lists OS or System alarms and events.

Table 11. OS or System Alarms and Events

Type Code	Identification Code	Alarm or Event
1	03073	Code unreachable
1	03074	Heap overflow
1	03075	Not enough memory in Heap
1	02817	A command is sent to an unavailable device CAN
1	02818	*Not used
1	02819	Impossible to open a session with a CAN device
1	02820	No answer from a CAN device
1	02821	*Not used
1	02822	The number of CAN devices discovered on CAN bus is too great
1	02823	Command unknown
1	02824	Device CAN Id out of range
1	02825	Time duration of a command is too long
1	02826	Report acquired from CAN device is wrong
1	02827	Report descriptor acquired from CAN device is wrong
1	01281	Mutex not available
1	01282	HID object Id out of range
1	01283	Report empty or not valid
1	01284	Report Id out of range
1	01285	Not enough memory in HEAP
1	01286	Duration of the acquisition of Teridian is too long
1	01282	HID object Id not in list of data saved in EEPROM
1	02561	*Not used
1	02562	*Not used

Table 11. OS or System Alarms and Events (Continued)

Type Code	Identification Code	Alarm or Event
1	02563	*Not used
1	02564	Wrong data type
1	02565	String too long
1	02566	*Not used
1	02567	*Not used
1	01025	*Not used
1	01026	Semantic error
1	01027	Impossible to open log file
1	01028	Impossible to write data in log file
1	01029	Impossible to seek data in log file
1	01030	Impossible to read data in log file
1	01031	Mutex not available
1	01032	*Not used
1	01033	Impossible to clear LOG file
1	03585	Initialization of SSH task failed
1	03586	Reading of the host key file (or table) failed
1	03587	Listening of SSH socket failed
1	03588	Acceptance of SSH socket failed
1	03589	Break received
1	03590	Max number of SSH connection reached
1	03591	Certificate error
1	03592	*Not used
1	03841	SNMP bad trap number

Type 2 or 3 (ePDU or User)

Type 2 alarms and events are triggered from the ePDU. These alarms and events are primarily threshold crossings when the operation measurement is beyond the threshold value range setting. Type 2 alarms and events also provide the state of optional connected equipment.

Type 3 alarms and events are triggered from user actions.

Figure 85 provides an example of a Type Code 2 ePDU alarm number code.

Number code 211402: Eaton ePDU Critical Overcurrent L2 Phase

**Figure 85. Example Type 2 Code**

Table 12 lists ePDU and User alarms and events.

Table 12. ePDU and User Alarms and Events

Type Code	Identification and Index Code	Alarm or Event	Description
2	201000	Dry Contact 1 Not Active	The signal for Dry Contact 1 is active.
2	201100	Dry Contact 1 Active	The signal for Dry Contact 1 is not active.
2	202000	Dry Contact 1 Open	Dry Contact 1 is open.
2	202100	Dry Contact 1 Closed	Dry Contact 1 is closed.
2	203000	Dry Contact 2 Not Active	The signal for Dry Contact 2 is active.
2	203100	Dry Contact 2 Active	The signal for Dry Contact 2 is not active.
2	204000	Dry Contact 2 Open	Dry Contact 2 is open.
2	204100	Dry Contact 2 Closed	Dry Contact 2 is closed.
2	205000	Sensor Probe Communication Failure Cleared	Sensor Probe communication failure is cleared
2	205100	Sensor Probe Communication Failure	Sensor probe communication failure detected
2	208000	Sensor Probe Not Connected	Sensor probe not connected since firmware startup
2	208100	Sensor Probe Connected	Sensor probe connected at least once since firmware startup
2	206000	Humidity No Threshold	No humidity threshold has been triggered.
2	206100	Humidity Warning Low Threshold	The humidity level reading is less than the value configured as the low humidity warning threshold.
2	206200	Humidity Critical Low Threshold	The humidity level reading is less than the value configured as the low humidity critical threshold.
2	206300	Humidity Warning High Threshold	The humidity level reading is greater than the value configured as the high humidity warning threshold.
2	206400	Humidity Critical High Threshold	The humidity level reading is greater than the value configured as the high humidity critical threshold.
2	207000	Temperature No Threshold	No temperature threshold has been triggered.
2	207100	Temperature Warning Low Threshold	The temperature level reading is less than the value configured as the low temperature warning threshold.
2	207200	Temperature Critical Low Threshold	The temperature level reading is less than the value configured as the low temperature critical threshold.
2	207300	Temperature Warning High Threshold	The temperature level reading is greater than the value configured as the high temperature warning threshold.
2	207400	ePDU Temperature Critical High Threshold	The temperature level reading is greater than the value configured as the high temperature critical threshold.
2	211000	ePDU Input 1 Current No Threshold	No section current threshold has been triggered.
2	211100	ePDU Input 1 Low Current Warning	The current amperage (A) reading for the specified section is less than the value configured as the low current warning alarm threshold.
2	211200	ePDU Input 1 Low Current Critical	The current amperage (A) reading for the specified section is less than the value configured as the low current critical alarm threshold.
2	211300	ePDU Input 1 Over Current Warning	The specified section current amperage (A) reading is greater than the value configured as the over current warning threshold.

Table 12. ePDU and User Alarms and Events (Continued)

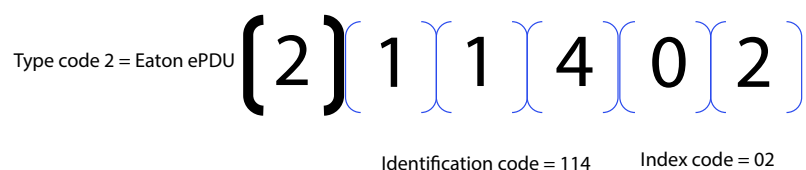
Type Code	Identification and Index Code	Alarm or Event	Description
2	211400	ePDU Input 1 Over Current Critical	The specified section current amperage (A) reading is greater than the value configured as the over current critical alarm threshold.
2	212000	ePDU Input 1 Voltage No Threshold	No section voltage threshold has been triggered.
2	212100	ePDU Input 1 Low Voltage Warning	The specified section voltage reading is less than the value configured as the low voltage warning threshold.
2	212200	ePDU Input 1 Low Voltage Critical	The specified section voltage reading is less than the value configured as the low voltage critical threshold.
2	212300	ePDU Input 1 Over Voltage Warning	The specified section voltage reading is greater than the value configured as the over voltage warning threshold.
2	212400	ePDU Input 1 Over Voltage Critical	The specified section voltage reading is greater than the value configured as the over voltage critical threshold.
2	213000	ePDU Input 1 Frequency OK	Utility frequency is within the +/- 3 Hz of Nominal frequency.
2	213100	ePDU Input 1 Frequency Out of Range	Utility frequency greater or less than +/- 3 Hz of Nominal frequency.
2	214000	ePDU Input 2 Current No Threshold	No section current threshold has been triggered.
2	214100	ePDU Input 2 Low Current Warning	The current amperage (A) reading for the specified section is less than the value configured as the low current warning alarm threshold.
2	214200	ePDU Input 2 Low Current Critical	The current amperage (A) reading for the specified section is less than the value configured as the low current critical alarm threshold.
2	214300	ePDU Input 2 High Current Warning	The specified section current amperage (A) reading is greater than the value configured as the over current warning threshold.
2	214400	ePDU Input 2 High Current Critical	The specified section current amperage (A) reading is greater than the value configured as the over current critical alarm threshold.
2	215000	ePDU Input 2 Voltage No Threshold	No section voltage threshold has been triggered.
2	215100	ePDU Input 2 Low Voltage Warning	The specified section voltage reading is less than the value configured as the low voltage warning threshold.
2	215200	ePDU Input 2 Low Voltage Critical	The specified section voltage reading is less than the value configured as the low voltage critical threshold.
2	215300	ePDU Input 2 High Voltage Warning	The specified section voltage reading is greater than the value configured as the over voltage warning threshold.
2	215400	ePDU Input 2 High Voltage Critical	The specified section voltage reading is greater than the value configured as the over voltage critical threshold.
2	216000	ePDU Input 2 Frequency OK	The frequency is not out of range.
2	216100	ePDU Input 2 Frequency out of +/- 3 Hz tolerance	The frequency is out of range.

Table 12. ePDU and User Alarms and Events (Continued)

Type Code	Identification and Index Code	Alarm or Event	Description
2	221000	ePDU Gang Phase Input Current No Threshold	No section current threshold has been triggered.
2	221100	ePDU Gang Phase Low Current Warning	The current amperage (A) reading for the specified section is less than the value configured as the low current warning alarm threshold.
2	221200	ePDU Gang Phase Low Current Critical	The current amperage (A) reading for the specified section is less than the value configured as the low current critical alarm threshold.
2	221300	ePDU Gang Phase Over Current Warning	The specified section current amperage (A) reading is greater than the value configured as the over current warning threshold.
2	221400	ePDU Gang Phase Over Current Critical	The specified section input current amperage (A) reading is greater than the value configured as the over current critical alarm threshold.
2	222000	ePDU Gang Phase Voltage No Threshold	No section voltage threshold has been triggered.
2	222100	ePDU Gang Phase Low Voltage Warning	The specified section voltage reading is less than the value configured as the low voltage warning threshold.
2	222200	ePDU Gang Phase Low Voltage Critical	The specified section voltage reading is less than the value configured as the low voltage critical threshold.
2	222300	ePDU Gang Phase Over Voltage Warning	The specified section voltage reading is less than the value configured as the over voltage warning threshold.
2	222400	ePDU Gang Phase Over Voltage Critical	The specified section voltage reading is less than the value configured as the over voltage critical threshold.
2	223000	ePDU Gang Not Alarmed	No alarm has been triggered.
2	223100	ePDU Gang Alarmed	An alarm has been triggered.
2	241000	Communication OK	No communication failure detected on Teridian RS-485 bus
2	241100	Communication Lost	Communication failure detected on Teridian RS-485 bus
2	251000	Daisy Chain Communication OK	No communication failure detected on Daisy Chain
2	251100	Daisy Chain Communication Alarmed	Communication failure detected on Daisy Chain
2	231000	ePDU Outlet Current No Threshold	No outlet current threshold has been triggered.
2	231100	ePDU Outlet Low Over Current Warning	The current amperage (A) reading for the specified outlet is less than the value configured as the low current warning alarm threshold.
2	231200	ePDU Outlet Low Over Current Critical	The current amperage (A) reading for the specified outlet is less than the value configured as the low current critical alarm threshold.
2	231300	ePDU Outlet High Over Current Warning	The specified outlet current amperage (A) reading is greater than the value configured as the over current warning threshold.
2	231400	ePDU Outlet High Over Current Critical	The specified outlet input current amperage (A) reading is greater than the value configured as the over current critical alarm threshold.

Table 12. ePDU and User Alarms and Events (Continued)

Type Code	Identification and Index Code	Alarm or Event	Description
2	232000	ePDU Outlet switch off	The specified outlet is Off.
2	232100	ePDU Outlet switch on	The specified outlet is On.
3	300100	Communication module restarted	The communication module has been restarted by the user.
3	300200	Ethernet cable connected	The Ethernet cable is connected.
3	300300	Ethernet cable not connected	The Ethernet cable is not connected.
3	300400	Factory reset requested by <interface>	A factory reset has been requested through the specified user interface.
3	300500	Ethernet card restart requested by <interface>	An Ethernet card restart has been requested through the specified user interface.
3	300600	Switch to bootloader mode for upgrade by <interface>	A Switch to bootloader mode for upgrade has been requested through the specified user interface.
3	300700	ePDU & System Log cleared	The ePDU & System Log have been cleared.
3	300800	Daisy Chain device does not answer	The Daisy Chain device does not answer.
3	300900	Time changed	The time was changed by the user.
3	301000	Daisy chain device connected	The daisy chain device is connected.
3	301100	Daisy chain device disconnected	The daisy chain device is disconnected.
3	301200	Upgrade request by user	An upgrade was requested by the user.
3	301300	Sensor connected	The sensor was connected.
3	301400	Sensor disconnected	The sensor was disconnected.
3	301500	Send mail test by user	The user sent a mail test.
3	301600	User logged in	The specified user logged in by the specified protocol.
3	301700	User logged out	The specified user logged out by the specified protocol.
3	301800	User logged in FTP	The specified user logged in by FTP.
3	301900	User logged out FTP	The specified user logged out by FTP.
3	302000	User failed to log FTP	The specified user failed to log by FTP.
3	302100	Ethernet card restart in USB mode	The Ethernet card has been restarted in USB mode.
3	302200	Network settings file uploaded from USB	The network settings file has been uploaded from the USB.
3	302300	eNMC module settings file uploaded from USB	The eNMC module settings file has been uploaded from the USB.
3	302400	ePDU settings file uploaded from USB	The ePDU settings file has been uploaded from the USB.

Chapter 10 Service and Support

If you have any questions or problems with the Eaton Enclosure Power Distribution Unit (ePDU) G3, call your **Local Distributor** or the **Help Desk** at one of the following telephone numbers and ask for an ePDU technical representative:

United States: **1-800-356-5737**
Canada: **1-800-461-9166 ext 260**
All other countries: **Call your local service representative**

Please have the following information ready when you call for service:

- Model number
- Serial number
- Date of failure or problem
- Symptoms of failure or problem
- Customer return address and contact information

Ordering Optional and Spare Parts

Table 13 provides the Eaton catalog part number for ordering optional and spare parts for the ePDU. Contact your local service representative for more information.

Table 13. Optional and Spare Parts

Eaton Catalog Number	Optional or Spare Part	Americas/APAC Market	EMEA/APAC Market	Description
EMP001	Optional	•	•	Eaton Environmental Monitoring Probe
SPK012	Spare Part	•		ePDU G3 Installation Spare Part Kit (US)
SPK013	Spare Part	•		ePDU G3 Network Spare Part Kit (US)
KSP020	Spare Part		•	ePDU G3 Spare Part Kit (EMEA)

Chapter 11 Warranty

Two-Year Limited Warranty (USA and Canada)

Eaton Enclosure Power Distribution Units (ePDUs)

WARRANTOR: The warrantor for the limited warranties set forth herein is Eaton (“Company”).

RACKMOUNTED LIMITED WARRANTY: This limited warranty (this “Warranty”) applies only to the original End-user (the “End-user”) of any Eaton Rackmounted Power Distribution Units (the “Product”) purchased on or after July 1, 2012, and cannot be transferred. This Warranty applies even in the event that the Product is initially sold by Company for resale to an End-user.

LIMITED WARRANTY PERIOD: The period covered by this Warranty for Product installed [and currently located] in the fifty (50) United States, the District of Columbia and Canada is twenty-four (24) months from the date of purchase, or thirty (30) months from the date of shipment. For units that are registered online at www.eaton.com/PQ/Register, the warranty is extended to thirty-six (36) months from the date of purchase, or fortytwo (42) months from the date of shipment.

WHAT THIS LIMITED WARRANTY COVERS: The warrantor warrants that the Product (the “Warranted Item”) is free from defects in material and workmanship. If, in the opinion of Company, a Warranted Item is defective and the defect is within the terms of this Warranty, Company’s sole obligation will be to repair or replace such defective Warranted Item (including by providing service, parts and labor, as applicable), at the option of Company.

PROCEDURES FOR REPAIR OR REPLACEMENT OF WARRANTED ITEMS:

Standard Product: Defined as ePDU product with the product number sequence PWxxxxxxxx or eXXXXX, (whereas x can be any value). The Warranted item will be repaired or replaced by the Company.

Custom Product: Defined as ePDU product with any product number sequence that does not equal a standard product as noted above. The Warranted item will be repaired at a Company site or such other location as determined by Company.

If the Warranted Item is to be replaced by Company, and the End-user supplies a credit card number or purchase order for the value of the replacement Product, Company will use commercially reasonable business efforts to ship (via standard ground shipment and at no cost to the End-user) the replacement Warranted Item to the End-user within one (1) business day after Company receives notice of the warranty claim. In such case, the End-user must return (at Company’s expense) the defective Warranted Item to Company in the same packaging as the replacement Warranted Item received by the End-user or as otherwise instructed by Company. If Company does not receive the defective Warranted Item, Company will either charge the End-user’s credit card, or send the End-user an invoice (which the End-user agrees to pay), for the value of the replacement Product.

If the Warranted Item is to be replaced by Company, but the End-user is unwilling or unable to supply a credit card number or purchase order for the value of the replacement Product, Company will use commercially reasonable business efforts to ship (via standard ground shipment and at no cost to the End-user) the replacement Warranted Item to the End-user within one (1) business day after Company receives the defective Product from the End-user.

In any case, Company will provide shipping instructions and will pay its designated carrier for all shipping charges for return of defective equipment and replacement of Warranted Items. Any returned Warranted Item or parts that are replaced may be new or reconditioned. All Warranted Items returned to Company and all parts replaced by Company shall become the property of Company.

Warranty

WHAT THIS LIMITED WARRANTY DOES NOT COVER: This Warranty does not cover any defects or damages caused by: (a) failure to properly store the Product before installation; (b) shipping and delivery of the Product if shipping is FOB Factory; (c) neglect, accident, abuse, misuse, misapplication or incorrect installation; (d) repair or alteration not authorized in writing by Company personnel or performed by an authorized Company Customer Service Engineer or Agent; (e) improper testing, operation, maintenance, adjustment or modification of any kind not authorized in writing by Company personnel or performed by an authorized Company Customer Service Engineer or Agent; or (f) use of the Product under other than normal operating conditions or in a manner inconsistent with the Product's labels or instructions.

This Warranty is not valid if the Product's serial numbers have been removed or are illegible. Any Warranted Items repaired or replaced pursuant to this Warranty will be warranted for the remaining portion of the original Warranty subject to all the terms thereof.

Company shall not be responsible for any charges for testing, checking, removal or installation of Warranted Items.

COMPANY DOES NOT WARRANT EQUIPMENT NOT MANUFACTURED BY COMPANY. IF PERMITTED BY THE APPLICABLE MANUFACTURER, COMPANY SHALL PASS THROUGH SUCH MANUFACTURER'S WARRANTIES TO END-USER.

COMPANY DOES NOT WARRANT SOFTWARE (IF APPLICABLE TO THE PRODUCT), INCLUDING SOFTWARE EMBEDDED IN PRODUCTS, THAT IS NOT CREATED BY COMPANY. WITHOUT LIMITING THE FOREGOING, COMPANY SPECIFICALLY DOES NOT WARRANT SOFTWARE (SUCH AS LINUX) THAT WAS CREATED USING AN "OPEN SOURCE" MODEL OR IS DISTRIBUTED PURSUANT TO AN OPEN SOURCE LICENSE.

THIS WARRANTY IS THE SOLE AND EXCLUSIVE WARRANTY OFFERED BY COMPANY WITH RESPECT TO THE PRODUCTS AND SERVICES AND, EXCEPT FOR SUCH FOREGOING WARRANTY COMPANY DISCLAIMS ALL OTHER WARRANTIES INCLUDING BUT NOT LIMITED TO ANY IMPLIED WARRANTIES OF MERCHANTABILITY, TITLE, NON-INFRINGEMENT AND FITNESS FOR A PARTICULAR PURPOSE. CORRECTION OF NONCONFORMITIES IN THE MANNER AND FOR THE PERIOD OF TIME PROVIDED ABOVE SHALL CONSTITUTE COMPANY'S SOLE LIABILITY AND ENDUSER'S EXCLUSIVE REMEDY FOR FAILURE OF COMPANY TO MEET ITS WARRANTY OBLIGATIONS, WHETHER CLAIMS OF THE END-USER ARE BASED IN CONTRACT, IN TORT (INCLUDING NEGLIGENCE OR STRICT LIABILITY), OR OTHERWISE.

LIMITATION OF LIABILITY: The remedies of the End-user set forth herein are exclusive and are the sole remedies for any failure of Company to comply with its obligations hereunder. In no event shall Company be liable in contract, in tort (including negligence or strict liability) or otherwise for damage to property or equipment other than the Products, including loss of profits or revenue, loss of use of Products, loss of data, cost of capital, claims of customers of the End-user or any special, indirect, incidental or consequential damages whatsoever. The total cumulative liability of Company hereunder whether the claims are based in contract (including indemnity), in tort (including negligence or strict liability) or otherwise, shall not exceed the price of the Product on which such liability is based.

Company shall not be responsible for failure to provide service or parts due to causes beyond Company's reasonable control.

END-USER'S OBLIGATIONS: In order to receive the benefits of this Warranty, the End-user must use the Product in a normal way; follow the Product's user's guide; and protect against further damage to the Product if there is a covered defect.

OTHER LIMITATIONS: Company's obligations under this Warranty are expressly conditioned upon receipt by Company of all payments due to it (including interest charges, if any). During such time as Company has not received payment of any amount due to it for the Product, in accordance with the contract terms under which the Product is sold, Company shall have no obligation under this Warranty. Also during such time, the period of this Warranty shall continue to run and the expiration of this Warranty shall not be extended upon payment of any overdue or unpaid amounts.

COSTS NOT RELATED TO WARRANTY: The End-user shall be invoiced for, and shall pay for, all services not expressly provided for by the terms of this Warranty, including without limitation, site calls involving an inspection that determines no corrective maintenance is required. Any costs for replacement equipment, installation, materials, freight charges, travel expenses or labor of Company representatives outside the terms of this Warranty will be borne by the End-user.

OBTAINING WARRANTY SERVICE: In the USA, call the Customer Reliability Center 7x24 at 800.356.5737. Outside of the USA, contact your local Eaton product sales or service representative, or call the Customer Reliability Center in the USA at 919.870.3149. For comments or questions about this Warranty, write to the Customer Quality Representative, 3301 Spring Forest Road, Raleigh, North Carolina 27616 USA.

Warranty