



Installation and User Manual

**1U Rack Model
5P 1550GR-L**



Copyright © 2017 Eaton
All rights reserved.

P-164000734 Rev 01

FCC Class A

This equipment has been tested and found to comply with the limits for a Class A digital device, pursuant to Part 15 of the FCC Rules. These limits are designed to provide reasonable protection against harmful interference when the equipment is operated in a commercial environment. This equipment generates, uses, and can radiate radio frequency energy and, if not installed and used in accordance with the instruction manual, may cause harmful interference to radio communications. Operation of this equipment in a residential area is likely to cause harmful interference in which case the user will be required to correct the interference at his own expense.

Certification Standards

- UPS directives: UL 1778 5th edition (UL listed).
- Performance: IEC 62040-3: 2001.
- Radiated emission: FCC CFR 47 part 15 subpart B, Class A.
- Surges withstand ability: IEEE ANSI C62.41 Category A2 (UL Listed).

Special Symbols

The following are examples of symbols used on the UPS or accessories to alert you to important information:



RISK OF ELECTRIC SHOCK - Observe the warning associated with the risk of electric shock symbol.



Important instructions that must always be followed.



Do not discard the UPS or the UPS batteries in the trash.
This product contains sealed lead acid batteries and must be disposed as it's explain in this manual.
For more information, contact your local recycling/reuse or hazardous waste center.



This symbol indicates that you should not discard waste electrical or electronic equipment (WEEE) in the trash. For proper disposal, contact your local recycling/reuse or hazardous waste center.



Information, advice, help.

Safety of Persons

- The system has its own power source (the battery). Consequently, the power outlets may be energized even if the systems is disconnected from the AC power source.
- Dangerous voltage levels are present within the system. It should be opened exclusively by qualified service personnel.
- The system must be properly grounded.
- The battery supplied with the system contains small amounts of toxic materials.
To avoid accidents, the directives listed below must be observed:
 - servicing of batteries should be performed or supervised by personnel knowledgeable about batteries and the required precautions.
 - when replacing batteries, replace with the same type of battery module.
 - do not dispose of the battery module in a fire. The battery module may explode.
 - the battery module constitutes a danger (electrical shock, burns). The short-circuit current may be very high.

Precautions must be taken for all handling:

- Wear rubber gloves and boots.
- Do not lay tools or metal parts on top of the battery module.
- Disconnect charging source prior to connecting or disconnecting battery terminals.
- Determine if battery is inadvertently grounded. If inadvertently grounded, remove source from ground. Contact with any part of a grounded battery can result in electrical shock. The likelihood of such shock can be reduced if such grounds are removed during installation and maintenance (applicable to equipment not having a grounded supply circuit).

Product Safety

- The UPS connection instructions and operation described in the manual must be followed in the indicated order.
- A protection circuit breaker must be installed upstream and be easily accessible.
The system can be disconnected from the AC power source by opening this circuit breaker.
- Check that the indications on the rating plate correspond to your AC powered system and to the actual electrical consumption of all the equipment to be connected to the system.
- For PLUGGABLE EQUIPMENT, the socket-outlet shall be installed near the equipment and shall be easily accessible.
- Never install the system near liquids or in an excessively damp environment.
- Never let a foreign body penetrate inside the system.
- Never block the ventilation grates of the system.
- Never expose the system to direct sunlight or source of heat.
- If the system must be stored prior to installation, storage must be in a dry place.
- The admissible storage temperature and humidity range:
 - 1 Month: 113 to 122°F / 45 to 50°C
 - 3 Month: 77 to 113°F / 25 to 45°C
 - 1 Year: 14 to 77°F / -10 to 25°C
 - Humidity: 45 to 60% RH
- The system is not for use in a computer room AS DEFINED IN the standard for the Protection of Information Technology Equipment, ANSI/NFPA 75 (US installations only).
Contact Eaton resellers to order a special battery kit, if needed to meet the ANSI/NFPA 75 requirement.

Special Precautions

- All handling operations will require at least two people (unpacking, installation in rack system).
- Before and after the installation, if the UPS remains de-energized for a long period, the UPS must be energized for a period of 24 hours, at least once every 3 months (recommended storage temperature is 77°F (25 °C)). This charges the battery, thus avoiding possible irreversible damage.
- During the replacement of the battery module, it is imperative to use the same type and number of elements as the original battery module provided with the UPS to maintain an identical level of performance and safety. In case of doubt, don't hesitate to contact your Eaton representative.

Table of Contents

1. Introduction.....	6
1.1 Environmental Protection.....	6
2. Presentation.....	7
2.1 Standard Installations.....	7
2.2 Rear Panel.....	8
2.3 Control Panel.....	9
2.4 LCD Description.....	10
2.5 Display Functions.....	11
2.6 User Settings.....	11
3. Installation.....	13
3.1 Unpacking and Contents Check.....	13
3.2 Rack Installation.....	14
3.3 Wall Mount Installation.....	15
3.4 Communication Ports.....	16
4. Operation.....	17
4.1 Start-up and Normal Operation.....	17
4.2 Starting the UPS on Battery.....	17
4.3 UPS Shutdown.....	17
4.4 Operation on Battery Power.....	17
4.5 Return of AC Input Power.....	18
4.6 UPS Remote Control Functions.....	18
5. Maintenance.....	19
5.1 Troubleshooting.....	19
5.2 Battery-Module Replacement.....	20
6. Appendices.....	21
6.1 Technical Specifications.....	21

1. Introduction

Thank you for selecting an Eaton product to protect your electrical equipment.

The 5P range has been designed with the utmost care.

We recommend that you take the time to read this manual to take full advantage of the many features of your uninterruptible power system (UPS).

Before installing your 5P, please read the booklet presenting the safety instructions. Then follow the instructions in this manual.

To discover the entire range of Eaton products and the options available for the 5P range, we invite you to visit our web site at www.eaton.com/powerquality or contact your Eaton representative.

1.1 Environmental Protection

EATON has implemented an environmental-protection policy. Products are developed according to an eco-design approach.

Substances

This product does not contain CFCs, HCFCs, or asbestos.

Packing

To improve waste treatment and facilitate recycling, separate the various packing components.

- The cardboard we use comprises over 50% of recycled cardboard.
- Sacks and bags are made of polyethylene.
- Packing materials are recyclable and bear the appropriate identification symbol



Materials	Abbreviations	Number in the symbols	
Polyethylene terephthalat	PET	01	
High-density polyethylene	HDPE	02	
Polyvinyl chloride	PVC	03	
Low-density polyethylene	LDPE	04	
Polypropylene	PP	05	
Polystyrene	PS	06	

Follow all local regulations for the disposal of packing materials.

End of Life

Eaton will process products at the end of their service life in compliance with local regulations. Eaton works with companies in charge of collecting and eliminating our products at the end of their service life.

Product

The product is made up of recyclable materials.

Dismantling and destruction must take place in compliance with all local regulations concerning waste. At the end of its service life, the product must be transported to a processing center for electrical and electronic waste.

Battery

The product contains lithium-ion (LFP) batteries that must be processed according to applicable local regulations concerning batteries.

The battery may be removed to comply with regulations and in view of correct disposal.

2. Presentation

2.1 Standard Installations

Dimensions

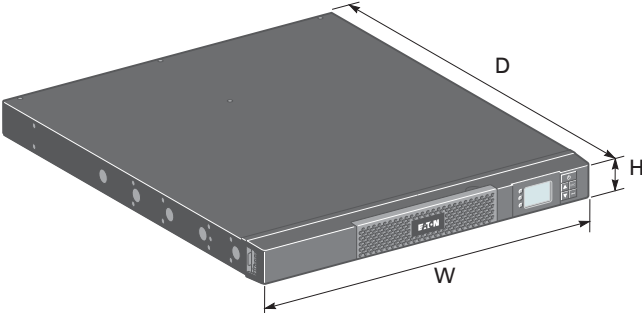

Description	Weights (lb/kg)	Dimensions (inch/mm) D x W x H
5P 1550GR-L	42.7 / 19.4	21.8 x 17.2 x 1.7 / 554 x 438 x 43

2. Presentation

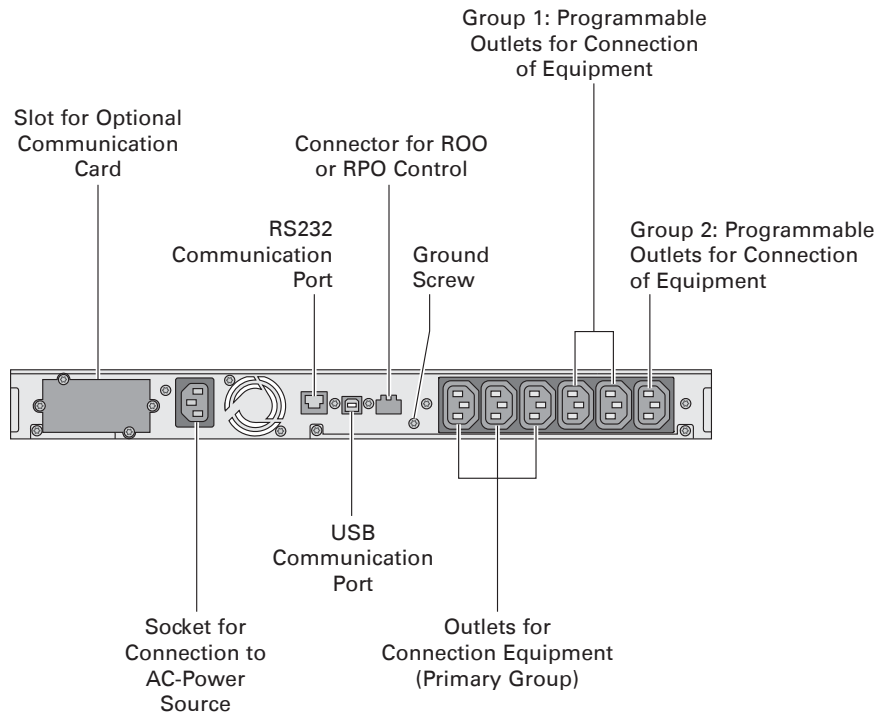

2.2 Rear Panel

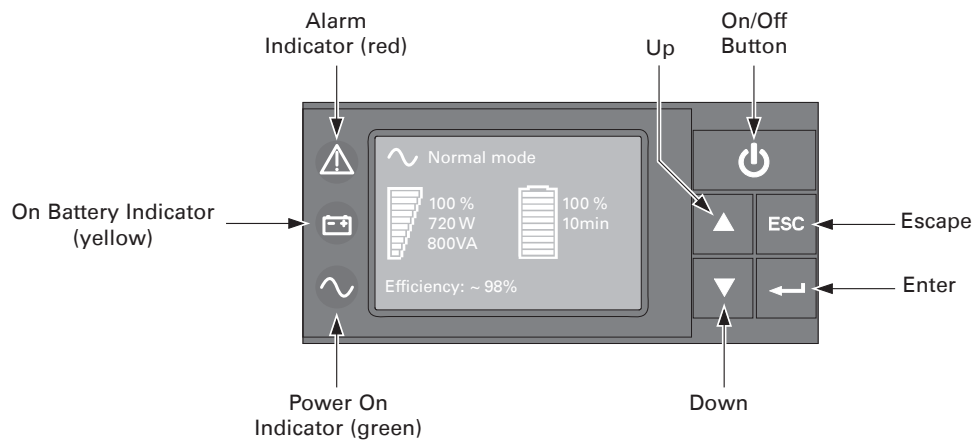

2.3 Control Panel



The following table shows the indicator status and description:

Indicator	Status	Description
 Green	On	Normal mode.
 Yellow	On	Battery mode.
 Red	On	Active alarm (see "Troubleshooting" on page 19).





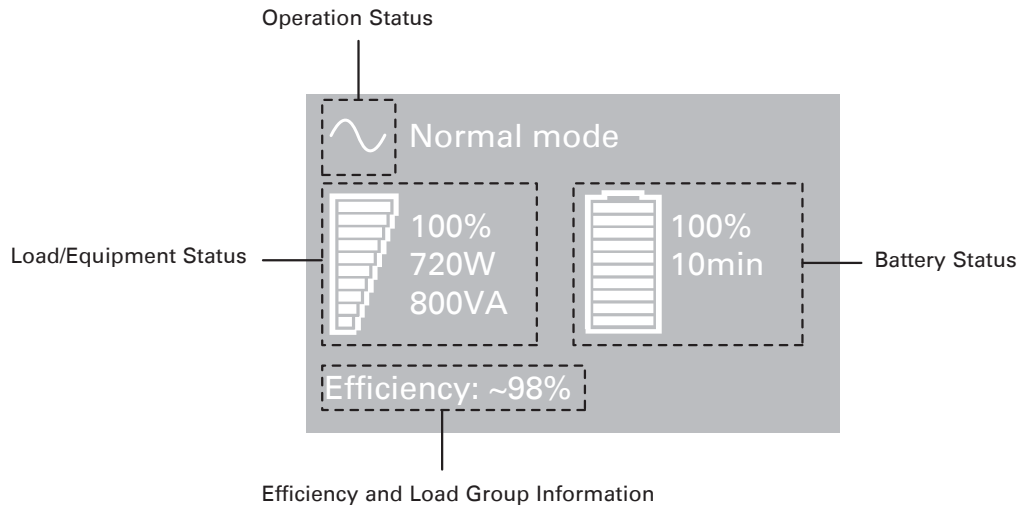

2. Presentation

2.4 LCD Description



As default, or after 5 minutes of inactivity, the LCD displays the screen saver. The backlight LCD automatically dims after 10 minutes of inactivity. Press any button to restore the screen.

Note: If any other indicator appears, see "Troubleshooting" on page 19.

UPS Operation Status	Possible Cause	Action
Standby mode 	The UPS is OFF, waiting for start-up command from user	Equipment is not powered until  button is pressed.
Normal mode 	The UPS is operating normally.	The UPS is powering and protecting the equipment.
In AVR mode  No beep	The UPS is operating normally but the utility voltage is outside normal mode thresholds.	The UPS is powering the equipment through a Automatic Voltage Regulation device. The equipment is still normally protected.
On Battery  Battery LED is on 1 beep every 10 seconds	A utility failure has occurred and the UPS is in Battery mode.	The UPS is powering the equipment with the battery power. Prepare your equipment for shutdown.
End of backup time  1 beep every 3 seconds	The UPS is in battery mode and the battery is running low.	This warning is approximate, and the actual time to shutdown may vary significantly. Depending on the UPS Load, the "Battery Low" warning may occur before the battery reaches 20% capacity.

2.5 Display Functions

Press the Enter (↵) button to activate the menu options. Use the two middle buttons (▲ and ▼) to scroll through the menu structure. Press the Enter (↵) button to select an option. Press the ESC button to cancel or return to the previous menu.

Menu map for Display Functions.

Main Menu	Submenu	Display Information or Menu Function
Measurements		Load W VA / Load A pf / Output V Hz / Input V Hz / Battery V min / Efficiency / Power usage
Control	Load Segments	Group 1: ON / OFF Group 2: ON / OFF These commands overrule user settings for load segments.
	Start battery test	Starts a manual battery test
	Reset fault state	Clears active faults (UPS restart required)
	Restore factory settings	Returns all settings to original values
	Reset power usage	Clears power usage measurements
Settings	Local settings	Sets product general parameters
	Input / output settings	Sets Input and output parameters
	ON / OFF settings	Sets ON / OFF conditions
	Battery settings	Sets battery configuration
Fault log		Displays event log or alarms
Identification		UPS Type / Part Number / Serial Number / Firmware release / Com card address

2.6 User Settings

The following table displays the options that can be changed by the user.

	Description	Available Settings	Default Settings
Local Settings	Language	[English] [Français] [Deutsch] [Italiano] [Português] [Español] [Русский] Menus, status, notices and alarms, UPS fault, Event Log data and settings are in all supported languages.	English User selectable when UPS is powered for the first time.
	LCD settings	Modify LCD screen brightness and contrast to adapt to room light conditions.	
	Audible alarm	[Enabled] [Disabled on battery] [Always disabled] Enable or disable the buzzer if an alarm occurs.	Enabled
In/Out Settings	Output voltage	[200 V] [208 V] [220 V] [230 V] [240 V]	User selectable when UPS is powered for the first time.
	Input thresholds	[Normal mode] [Extended mode] Extended mode reduces lower input voltage to 70V before UPS transfers to battery. This can be used if the load can withstand low voltage supply.	Normal mode
	Sensitivity	[High] [Low] High: for sensitive equipment, UPS will easily transfer to battery when utility conditions are becoming bad. Low: for equipment that can withstand bad utility conditions, in that case, the UPS will not transfer to battery.	High
	Load segments - Auto start delay	[No Delay] [1 s] [2 s]...[65354 s] The connected load is powered after the specified delay.	Group 1: 3 s Group 2: 6 s

2. Presentation

	Description	Available Settings	Default Settings
In/Out Settings	Load segments - Auto shutdown delay	[Disable] [0s] [1 s] [2 s]...[65354 s] During a power outage, authorizes UPS to turn off power to equipment connected to Group 1 and/or Group 2 outlets. This feature allows the shedding of non-critical loads in order to conserve battery power for critical loads connected to the Primary group.	Group 1: Disable Group 2: Disable
	Overload prealarm	[10 %] [15 %] [20 %] ... [100 %] [105 %] Sets critical percentage of load where alarm overload alarm occurs.	[105 %]
ON/OFF Settings	Cold start	[Disable] [Enable] Enables the product to be started on battery power. First cold start is always disabled.	Enable
	Forced reboot	[Disable] [Enable] If mains recover during a shutdown sequence: - if enabled, shutdown sequence will complete and wait 10 seconds prior to restart - if disabled, shutdown sequence will not complete and restart will occur immediately.	Enable
	Auto restart	[Disable] [Enable] Enables the product to restart automatically when mains recovers after a complete battery discharge.	Enable
	Energy saving	[Disable] [Enable] If enabled, UPS will shutdown after 5 min of back-up time, if no load is detected on the output.	Disable
	Sleep mode	[Disable] [Enable] If disabled, LCD and communication will turn OFF immediately after UPS is OFF. If enabled, LCD and communication stays ON 1h30 min after UPS is OFF.	Disable
	Remote command	[Disable] [Enable] If enabled, shutdown or restart commands from software are authorized.	Enable
	RPO delay	[0 s] [1s] [2 s]...[180 s] Delays remote power off command	[0 s]
Battery Settings	Low battery warning	[1 %] [2 %] ... [100 %] The alarm triggers when the set percentage of battery capacity is reached during a back-up time.	20 %
	Restart battery level	[1 %] [2 %] ... [100 %] If set, automatic restart will occur only when percentage of battery charge is reached.	0 %

3. Installation

3.1 Unpacking and Contents Check

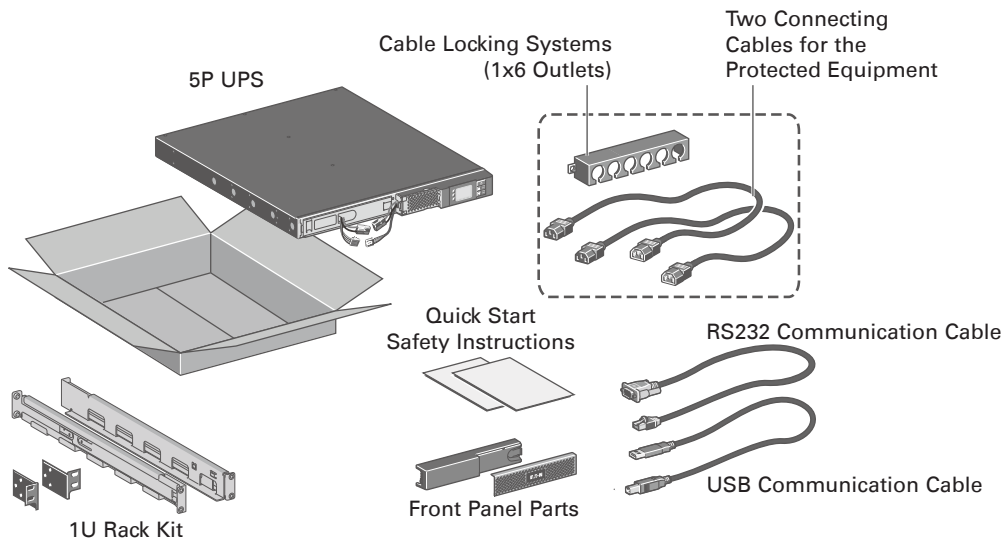

Packing materials must be disposed of in compliance with all local regulations concerning waste. Recycling symbols are printed on the packing materials to facilitate sorting.

3. Installation

3.2 Rack Installation

Follow Steps 1 through 4 for mounting the UPS on the rails.

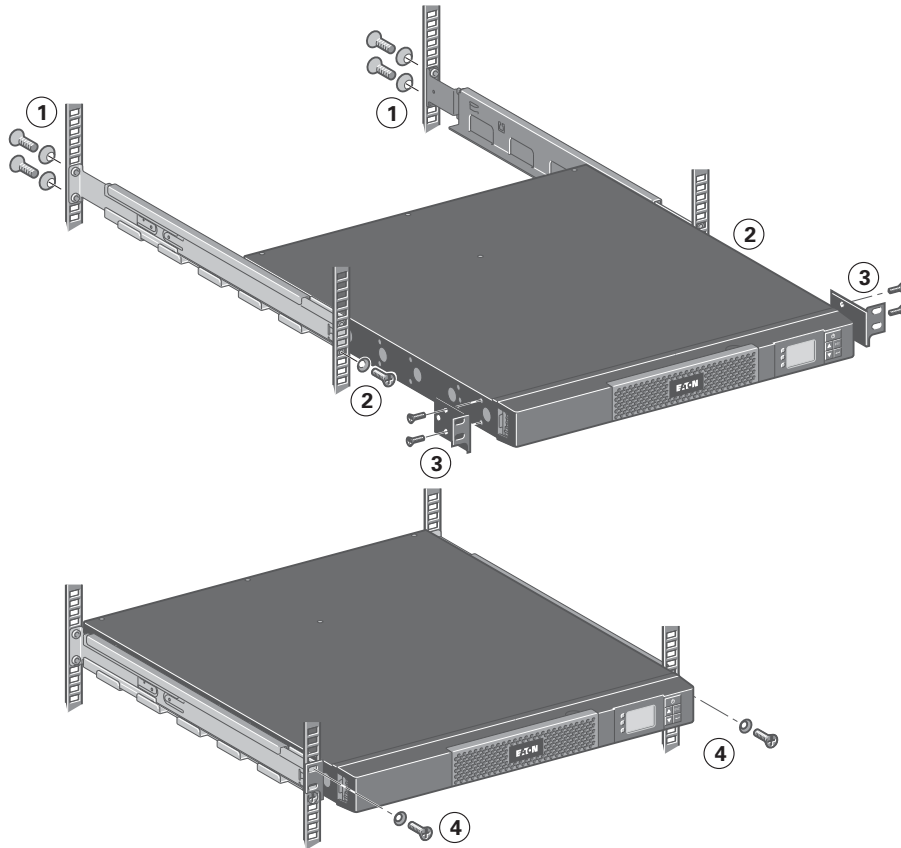

The rails and necessary hardware are supplied by Eaton.

3.3 Wall Mount Installation

Follow Steps 1 and 2 for mounting the UPS on the wall.

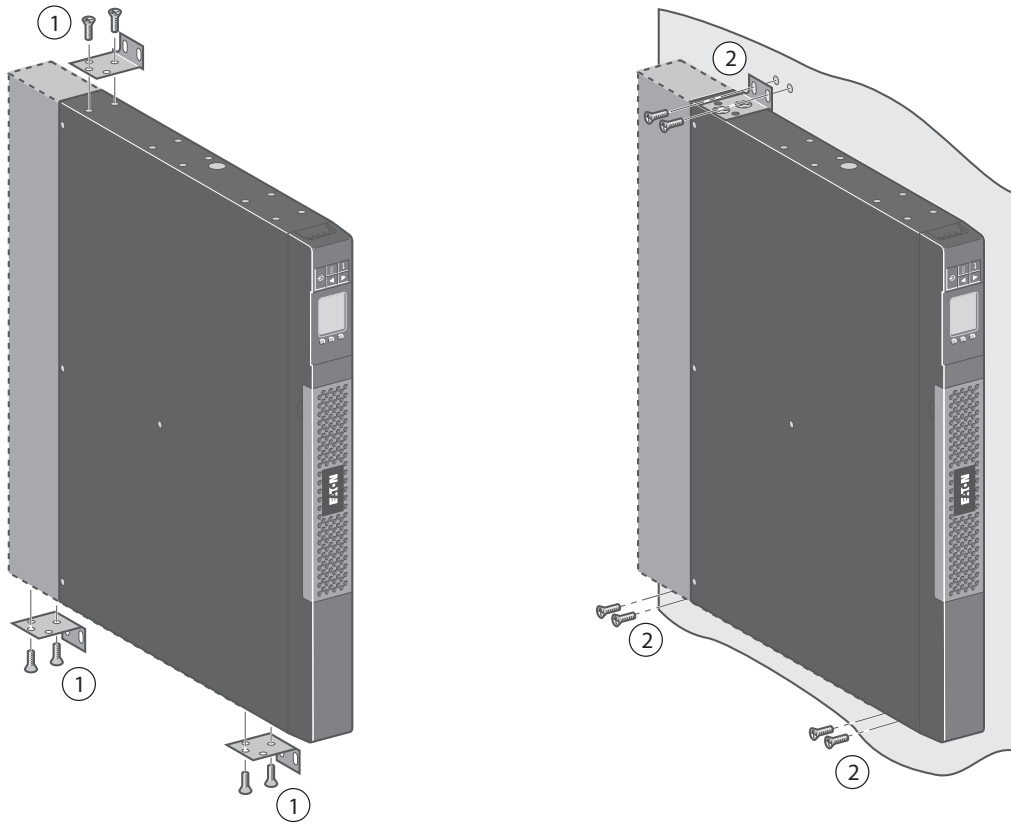

3. Installation

3.4 Communication Ports

Connection of RS232 or USB Communication Port

The RS232 and USB communication ports cannot operate simultaneously.

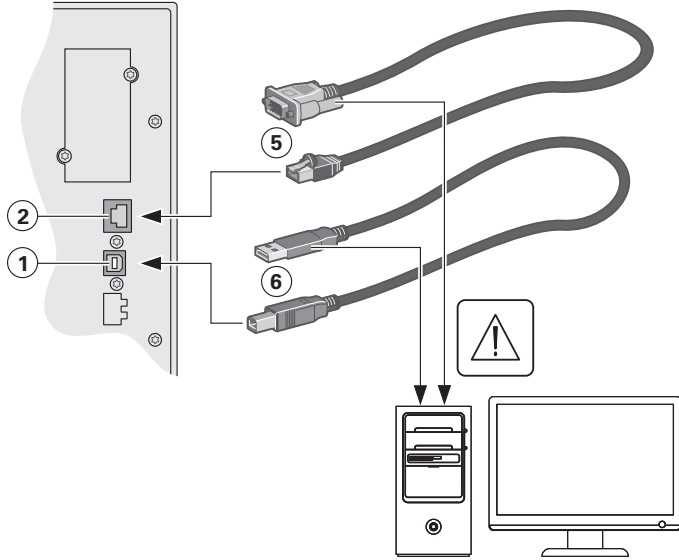

1. Connect the RS232 (5) or USB (6) communication cable to the serial or USB port on the computer equipment.

2. Connect the other end of the communication cable (5) or (6) to the USB (1) or RS232 (2) communication port on the UPS.

The UPS can now communicate with Eaton power management software.

Installation of the communication cards (optional, standard on the Network bundle models)

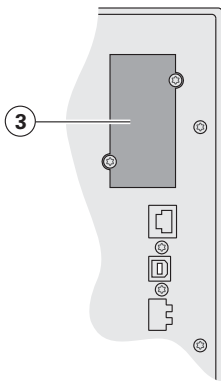

It is not necessary to shutdown the UPS before installing a communication card.

1. Remove the slot cover (3) secured by screws.
2. Insert the communication card in the slot.
3. Secure the card cover with the 2 screws.

Characteristics of the optocouplers communication port (optional)

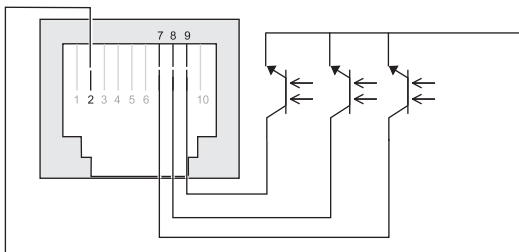

- Pins 1, 3, 4, 5, 6, 10: not used
- Pin 2: common (user)
- Pin 7: low battery
- Pin 8: operation on battery power
- Pin 9: UPS ON, equipment supplied

n.o.: normally open contact

When a signal is activated, the contact is closed between the common (pin 2) and the pin for the corresponding signal.





Contact characteristics (optocoupler)

- Voltage: 48 Vdc max
- Current: 25 mA max
- Power: 1.2W

4. Operation

4.1 Start-up and Normal Operation

To start the UPS:

1. Verify that the UPS power cord is plugged in.
2. The UPS front panel display illuminates and shows the Eaton logo.
3. Verify that the UPS status screen shows .
4. Press the  button on the UPS front panel for at least 2 seconds.
The UPS front panel display shows "UPS starting..."
5. Check the UPS front panel display for active alarms or notices. Resolve any active alarms before continuing. See "Troubleshooting" on page 19.
If the  indicator is on, do not proceed until all alarms are clear. Check the UPS status from the front panel to view the active alarms. Correct the alarms and restart if necessary.
6. Verify that the  indicator illuminates solid, indicating that the UPS is operating normally and any loads are powered and protected.
The UPS should be in Normal mode.



4.2 Starting the UPS on Battery



Before using this feature, the UPS must have been powered by utility power with output enabled at least once.

Battery start can be disabled. See the "Cold start" setting in "ON/OFF Settings" on page 12.

To start the UPS on battery:

1. Press the  button on the UPS front panel until the display illuminates and shows "UPS starting..."
The UPS cycles through Standby mode to Battery mode. The  indicator illuminates solid and the UPS powers your equipment.
2. Check the UPS front panel display for active alarms or notices (other than the "Battery mode" notice and notices that indicate missing utility power). Resolve any active alarms before continuing. See "Troubleshooting" on page 19.
If the  indicator is on, do not proceed until all alarms are clear. Check the UPS status from the front panel to view the active alarms. Correct the alarms and restart if necessary.

4.3 UPS Shutdown



To shut down the UPS:

Press the  button on the UPS front panel for three seconds.

The UPS starts to beep and shows a status of "UPS shutting OFF..." The UPS then transfers to Standby mode, and the  indicator turns off.

4.4 Operation on Battery Power

Transfer to Battery Power

- The connected devices continue to be supplied by the UPS when AC input power is no longer available. The necessary energy is provided by the battery.
- The  and  indicators illuminate solid.
- The audio alarm beeps every ten seconds.



The connected devices are powered by the battery.

4. Operation

Low-Battery Warning

- The \sim and BATT indicators solid.
- The audio alarm beeps every three seconds.



The remaining battery power is low. Shut down all applications on the connected equipment because automatic UPS shutdown is imminent.

End of Battery Backup Time

- LCD displays "End of backup time".
- All the LEDs go OFF.
- The audio alarms stops.

4.5 Return of AC Input Power

Following an outage, the UPS restarts automatically when AC input power returns (unless the restart function has been disabled) and the load is supplied again.

4.6 UPS Remote Control Functions

The 5P offers a choice between two remote control functions.

- **RPO: Remote Power Off** allows a remote contact to be used to disconnect all the equipment connected to the UPS. Restarting the UPS requires manual intervention.
- **ROO: Remote ON/OFF** allows remote action of the ON/OFF button to shut down the UPS.

These functions are obtained by opening a contact connected between the appropriate pins of connector (4) on the rear panel of the UPS (see figures below).

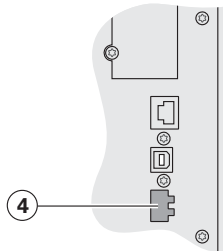

Remote Control Connection and Test

1. Check that the UPS is OFF and disconnected from the AC input source.
2. Remove connector (4).
3. Connect a normally closed volt-free contact (60 Vdc / 30 Vac max., 20 mA max., 0.75 mm² [18 AWG] cable cross-section) between the two pins of connector (4) (see diagram).

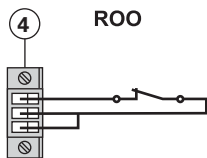

ROO

Contact open: UPS shutdown

Contact closed: UPS start-up (UPS connected to AC power and AC power is available)

Note: The local ON/OFF control using the ON/OFF button overrides the remote-control function.

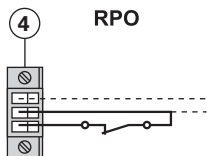

RPO

Contact open: UPS shutdown, Δ indicator illuminates

To return to normal operation, deactivate the remote external contact and restart the UPS by pressing the ON/OFF button.







4. Plug connector (4) into the back of the UPS.
5. Connect and restart the UPS following the previously described procedures.
6. Activate the external remote shutdown contact to test the function.



Warning. This connector must only be connected to SELV (Safety Extra-Low Voltage) circuits.

5. Maintenance

5.1 Troubleshooting

UPS Operation Status	Possible Cause	Action
Batteries disconnected 	The UPS does not recognize the internal batteries. The batteries are disconnected.	If the condition persists, contact your service representative. Verify that all batteries are properly connected. If the condition persists, contact your service representative.
Overload 	Power requirements exceed the UPS capacity (greater than 105 % of nominal).	Remove some of the equipment from the UPS. The UPS continues to operate, but may shutdown if the load increases. The alarm resets when the condition becomes inactive.
End of battery life 	The end of the battery life is reached.	Contact your service representative for battery replacement.
Event 	A UPS event occurs. Example: Remote Power OFF, the RPO contact has been activated to shutdown the UPS and now prevents restart.	Set the contact back to its normal position and press the  button to restart.
UPS fault 	The UPS has an internal fault.	The UPS does not protect the equipment anymore. Note: The alarm message and the UPS Serial Number, then contact your service representative.

5. Maintenance

5.2 Battery-Module Replacement

Safety Recommendations

The battery can cause electrocution and high short-circuit currents. The following safety precautions are required before servicing the battery components:

- remove watches, rings, bracelets and all other metal objects from the hands and arms,
- use tools with an insulated handle.

Battery Module Removal

This operation must be performed when the UPS is OFF.

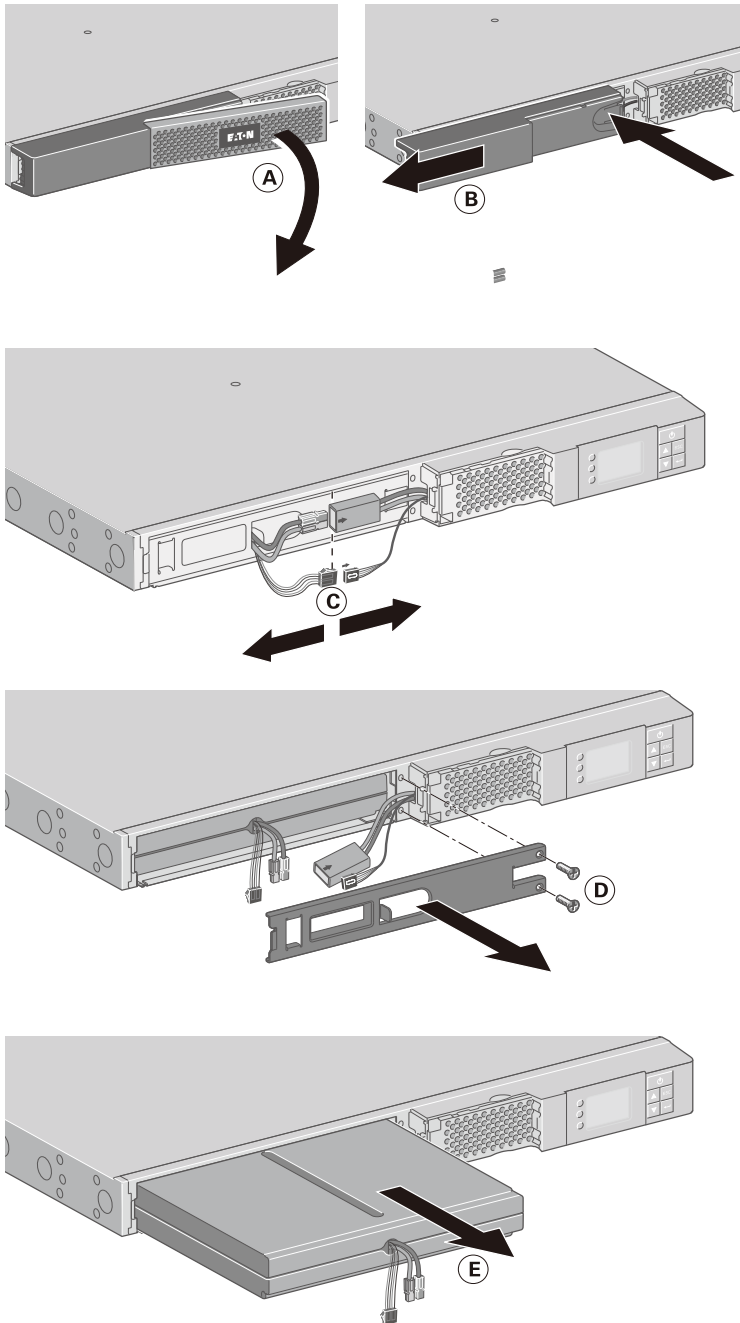

Battery Module Replacement

Carry out the above instructions in reverse order.



- To ensure safety and high performance, use only batteries supplied by Eaton.
- Take care to firmly press together the two parts of the connector during remounting.

6. Appendices

6.1 Technical Specifications

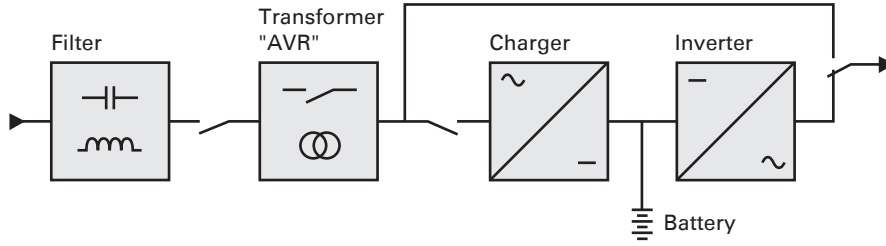

5P 1550GR-L	
Output Power @ 230V	1550 VA 1100W
Output Power Capacity @ 208V	1395 VA 990W
Output Power @ 200V	1395 VA 990W
AC Input power	
• Rated input voltage	Single phase 200-240V
• Input voltage range	160 to 294 V ⁽¹⁾
• Input frequency range	47 to 70 Hz (50 Hz system), 56.5 to 70 Hz (60 Hz system) ⁽²⁾
Output on battery power	
• Voltage	200/208/220/230/240V (-10/+6 %) ⁽³⁾
• Frequency	50/60 Hz ±0.1 Hz
Battery (LFP Lithium-Ion Batteries)	
• Standard	12 x 3.2V 6 Ah
Environment	
• Operating temperature range	41 to 104°F / 5 to 40°C
• Storage temperature range	5 to 104°F / -15 to 40°C
• Relative humidity	0 to 90 % (non-condensing)
• Noise level	< 40 dBA

(1) The high and low thresholds can be adjusted using UPS settings.

(2) Up to 40 Hz in low -sensitivity mode (programmable using UPS settings).

(3) Adjustable to 200/208/220/230/240V, must be set to the identical AC power source value.

When the appliance is used in EU area, use an external circuit breaker in front of line with rating 16A, 250V which is IEC/EN 60898-1 standard compliant.

When the appliance is used in America area, use an external circuit breaker in front of line with rating 20A, 250V.

This product is designed for IT power distribution system.